

無線網路多媒體系統 Wireless Multimedia System (Topic 4)

Medium Access Control II Bluetooth and WLAN

We
provide
無線網路多媒體實驗室
Wireless
Wireless Network & Multimedia Laboratory
Solution

Topic III Agenda

- ◆ **Wireless Link**
 - Ad Hoc MAC
 - ◆ Bluetooth
 - ◆ 802.11
 - Cellular MAC
 - ◆ GPRS



Demand for Medium Access Control

Voice Network
Data Network



Multimedia
Network

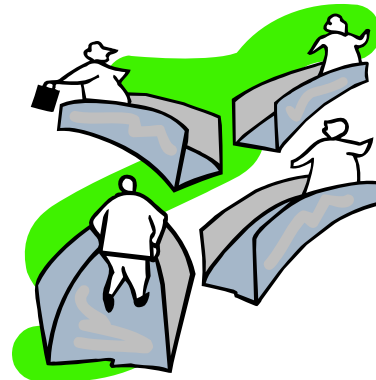
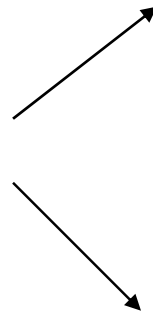

Soft Resource
Flexible QoS

Can we distinguish the traffic and offer different QoS?



→
Data: WWW, Email
Voice: telephone
Video: streaming



→
Calendar
Earphone
VideoClip



Possible Solutions



GPRS (GSM)

802.11

Bluetooth

Basic Questions

- ◆ How to deliver my stuff safely?



Three Concerns

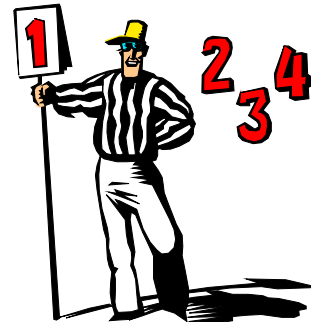

Control Resource

Acquiring Channel

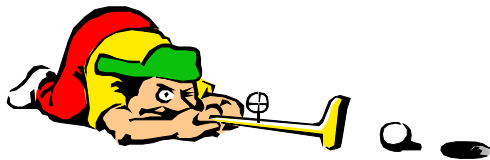

Collision
Free



CTS might be collided

- ◆ Whether CTS could be alive?

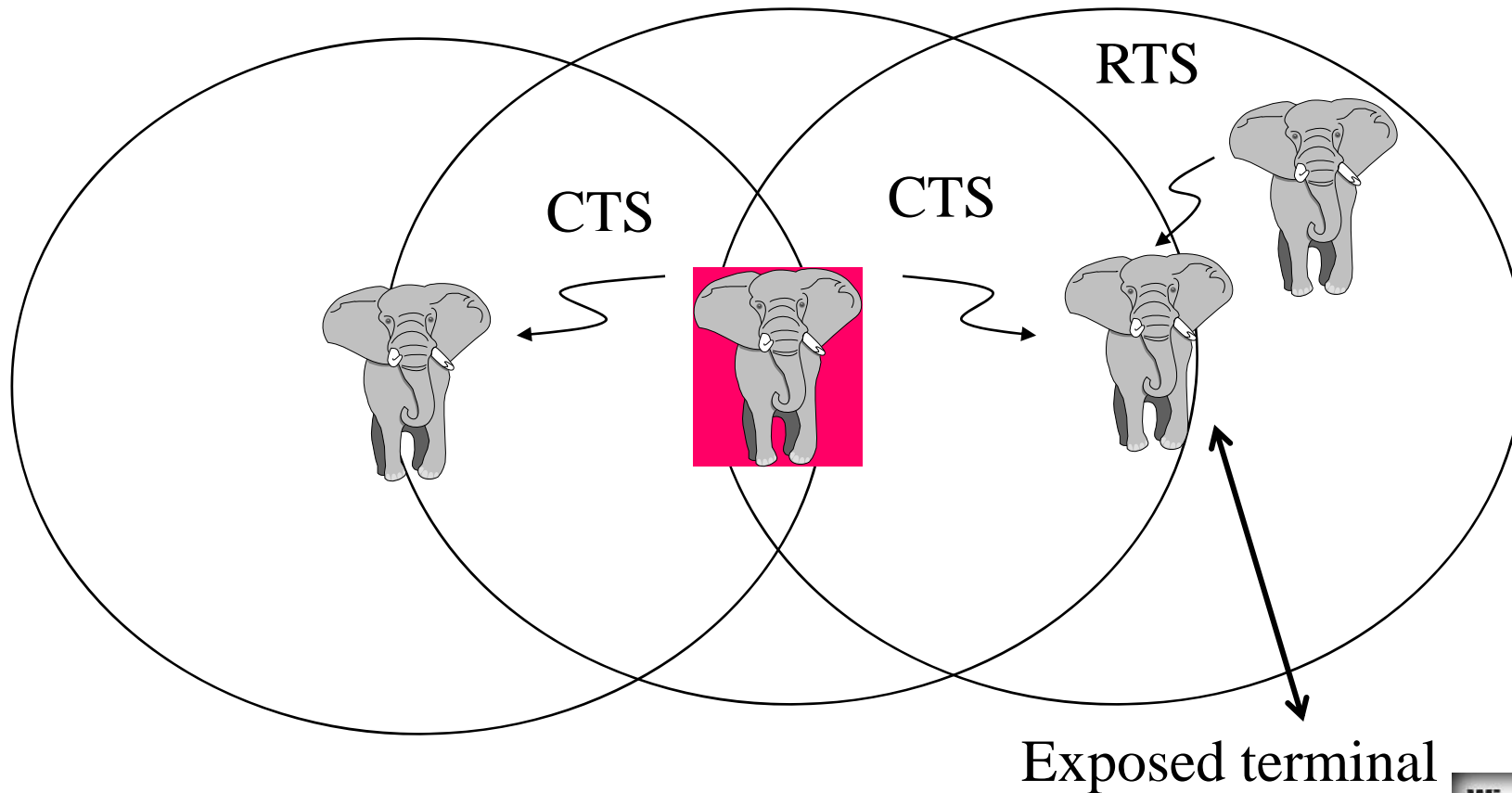

Basic Issues for Channel Access

◆ Channel Acquisitions?

- Aloha (go ahead)
- CSMA (signal sensing)
- 802.11 (through RTS/CTS dialog, CW for backoff procedure $T_{\text{backoff}} = \text{Rand}(0, CW) * T_{\text{slot}}$)
- Collision free (through effective CTS)
- MACAW (through RTS/CTS/DS/DATA/ACK)
- PCMA (through power control and busy tone)

◆ Collision Channel Transmissions

- Centralized Control or Distributed Control
- QoS
- Cycle Time.

◆ Spread Spectrum

- Interference suppression

Reading list for This Lecture

- ◆ **Required Reading:**

(Haartsen2000) Jaap C. Haartsen, "The Bluetooth Radio System", IEEE Personal Communications, February 2000

(Barry2001) Michael Barry, Andrew T. Campbell, Andras Veres, "Distributed Control Algorithms for Service Differentiation in Wireless Packet Networks", IEEE Infocom 2001

(Cai1997) Jian Cai and David J. Goodman, "General Packet Radio Service in GSM", IEEE Communication Magazine, Oct 1997

History of Mobile Ad Hoc Network (MANET)

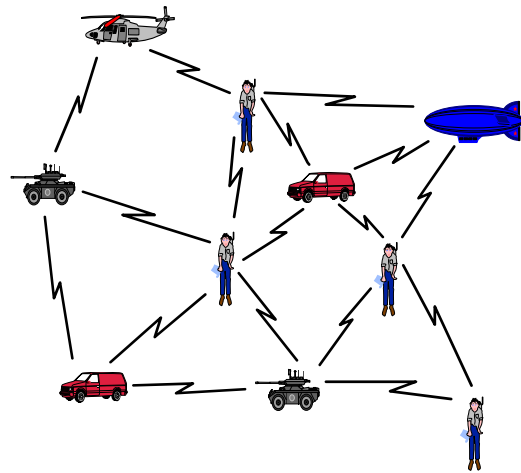

1972, DAPA Pnet
CSMA

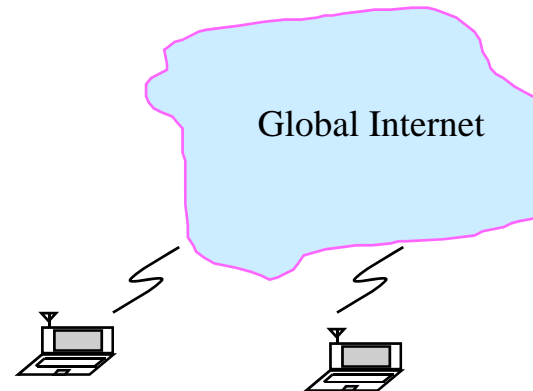
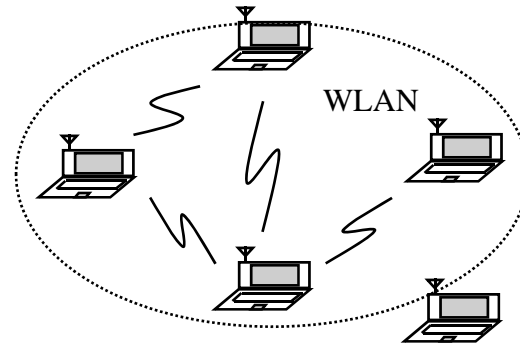

1994 GloMo
802.11

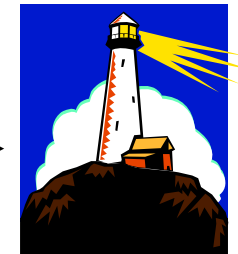

Commercial Applications of Ad hoc Network

- ◆ Conferencing
- ◆ Home Networking
- ◆ Emergency Services
- ◆ Personal Area Networks and Bluetooth
- ◆ Embedded Computing Applications
- ◆ Sensor Dust
- ◆ Automotive/PC Interaction
- ◆ Other Envisioned Applications



Technical and Market Factors for Ad hoc Networks



- ◆ Scalability
- ◆ Power Budget versus Latency
- ◆ Protocol Deployment and Incompatible Standards
- ◆ Wireless Data Rates
- ◆ User Education and Acculturation
- ◆ Additional Security Exposure
- ◆ Spotty Coverage



Bluetooth

supported by Ericsson, Nokia, Ibm, Toshiba, Intel..etc



Personal Area Network

Embedded Computing Applications

Ubiquitous Computing

<http://inrg.csie.ntu.edu.tw/wms>

Smart Spaces and Devices

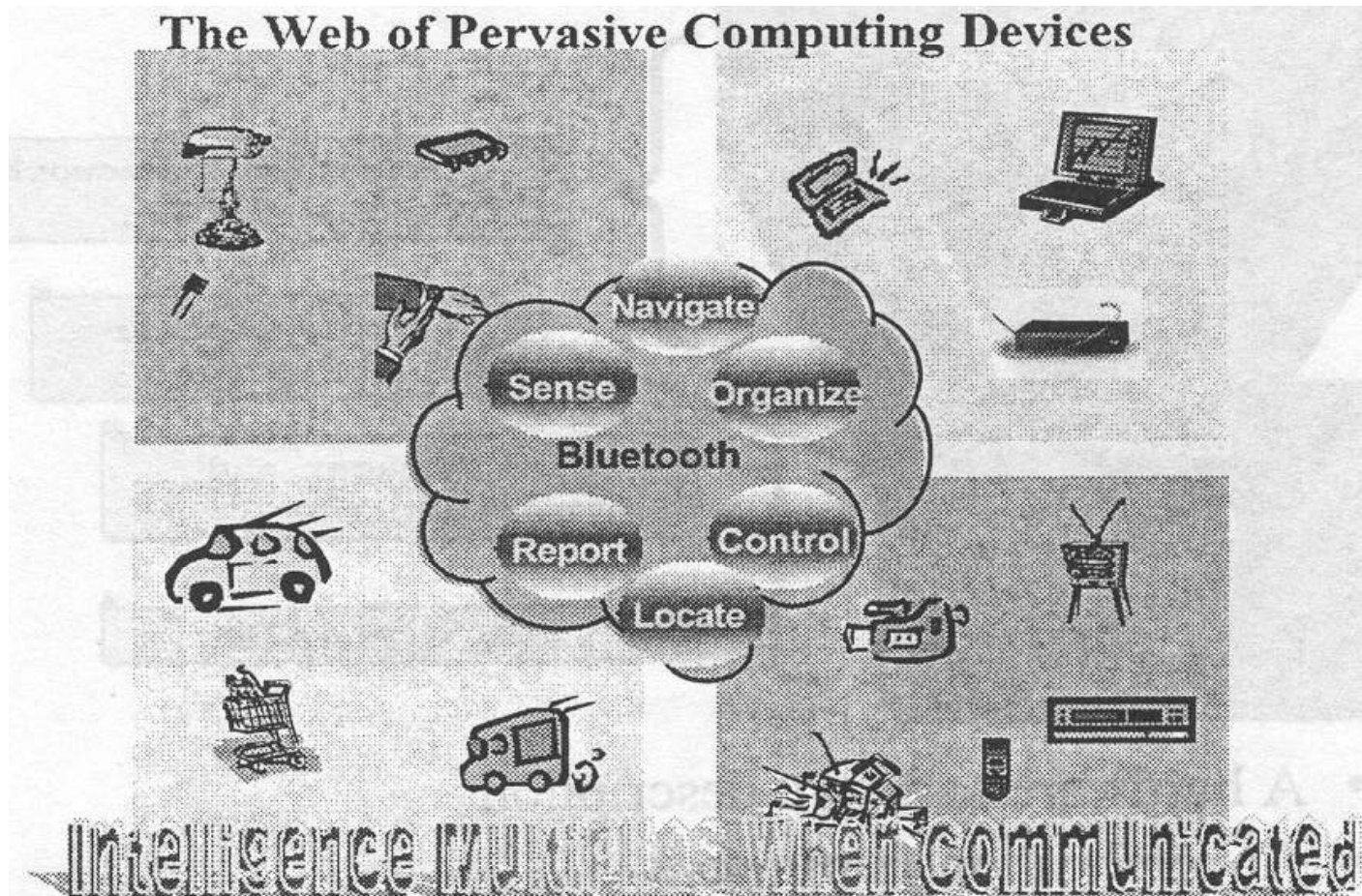

Spread Spectrum vs. Narrow Band

◆ Spread Spectrum Signal Characteristics

- ◆ The bandwidth of the transmitted signal is much greater than the original message bandwidth
- ◆ The bandwidth of the transmitted signal is determined by a spreading function (code), independent of the message, and known only to transmitter and receiver

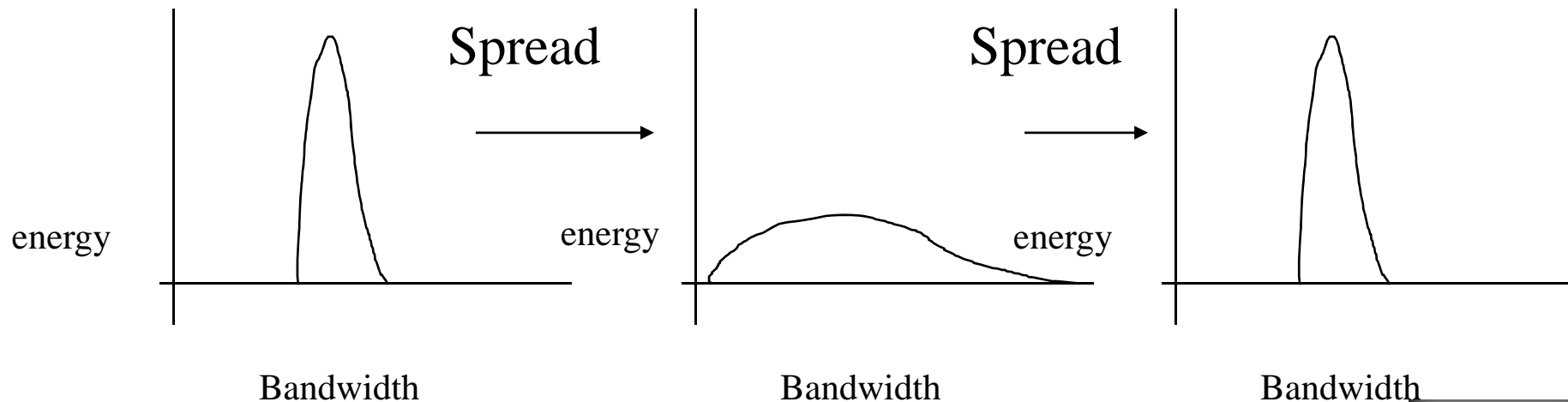

Direct Sequence Spread Spectrum

To transmit a 0 the station use a unique “chip sequence”:

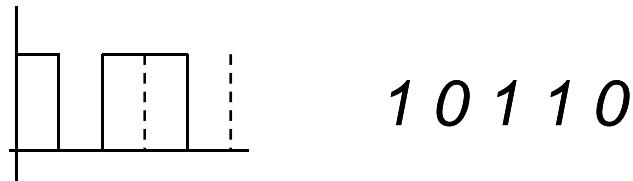

To transmit a 1 the station use the one's complement of its chip sequence:

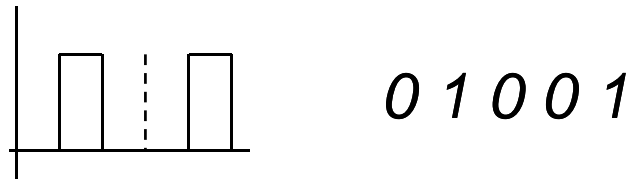

Therefore if data is 1010 it will transmit:

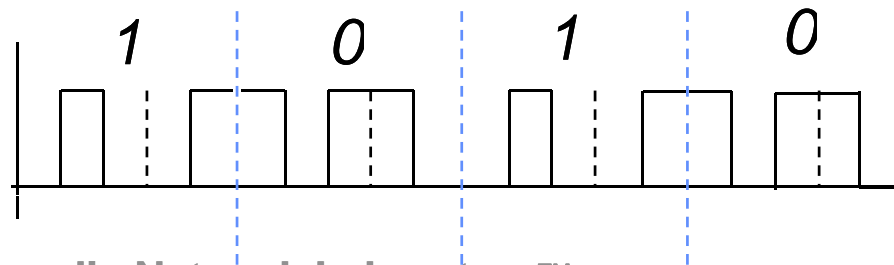

Frequency Hopping Spread Spectrum

- ◆ Transmitted signal is spread over a wide range of frequencies. (i.e. 2.400-2.485 GHz)
- ◆ Transmission usually hop 35 times per second.

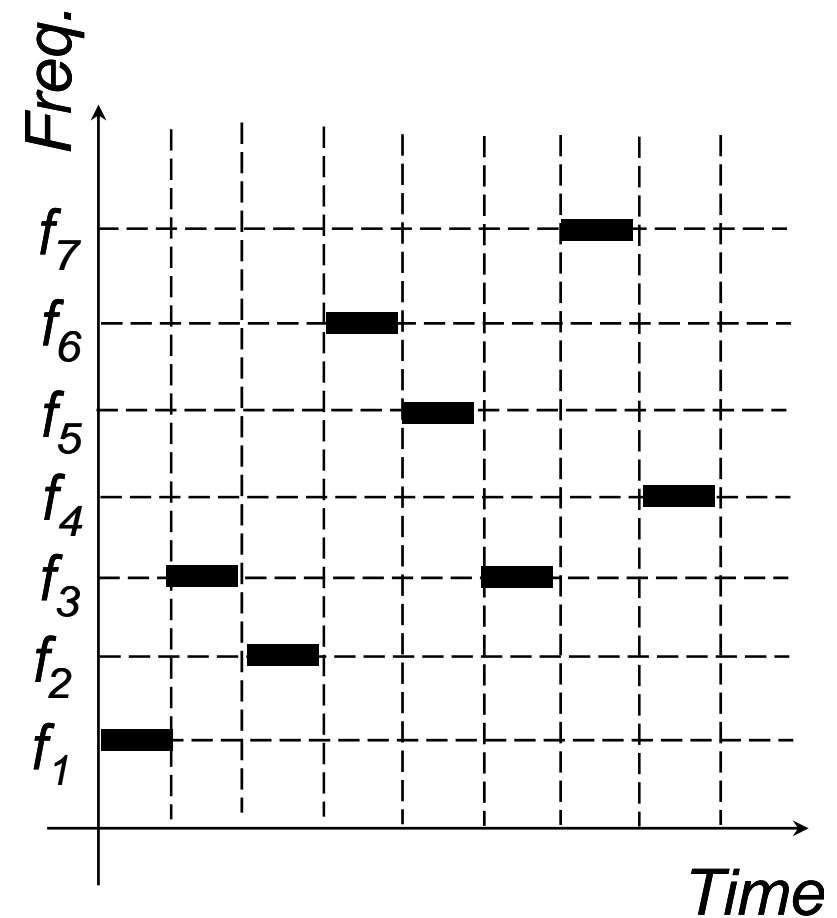

Rake Receiver

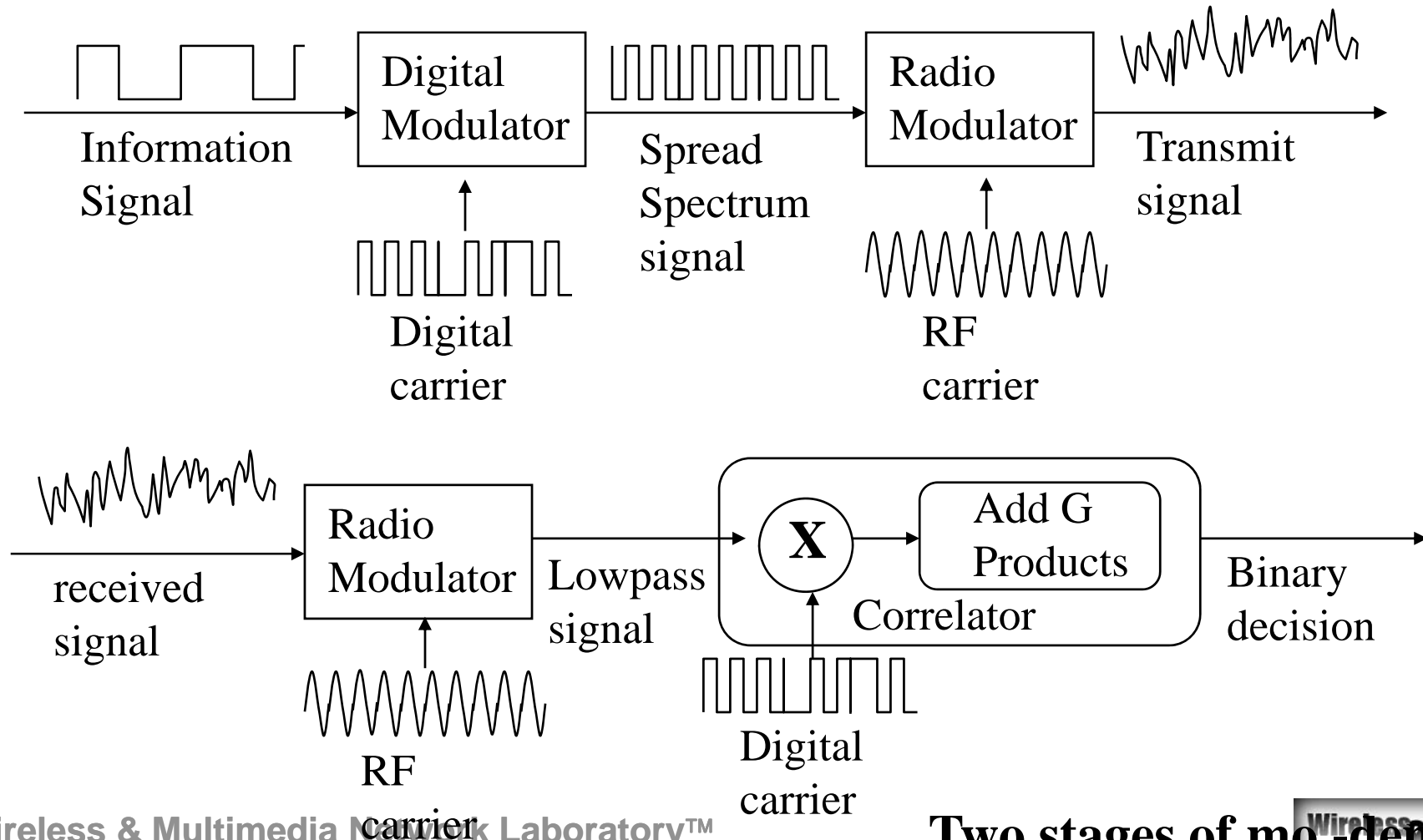

Rake Receiver (cont.)

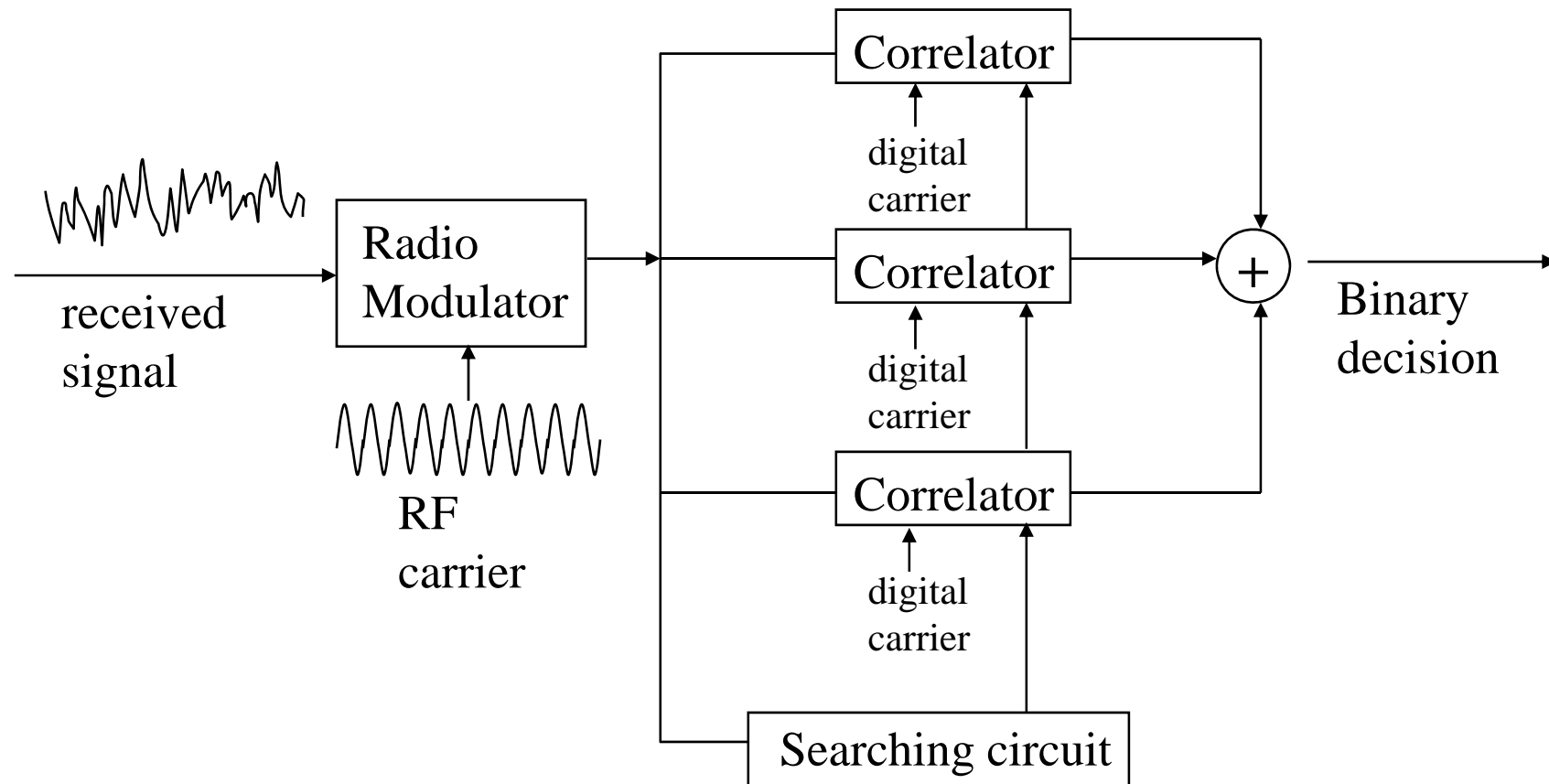

The Industrial, Scientific, and Medical frequency bands(ISM)



The spectrum is not coordinated by operator, open to the public

ISM Bands in Taiwan

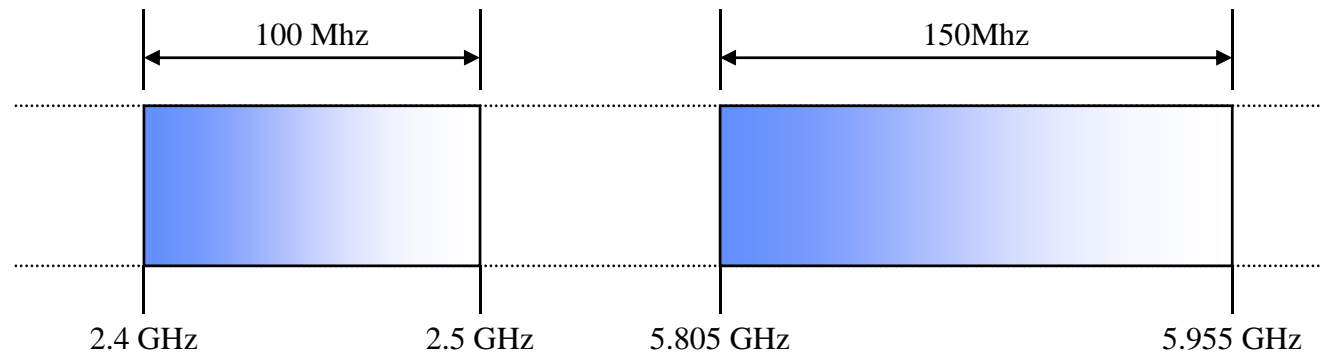

Typical Bluetooth Service

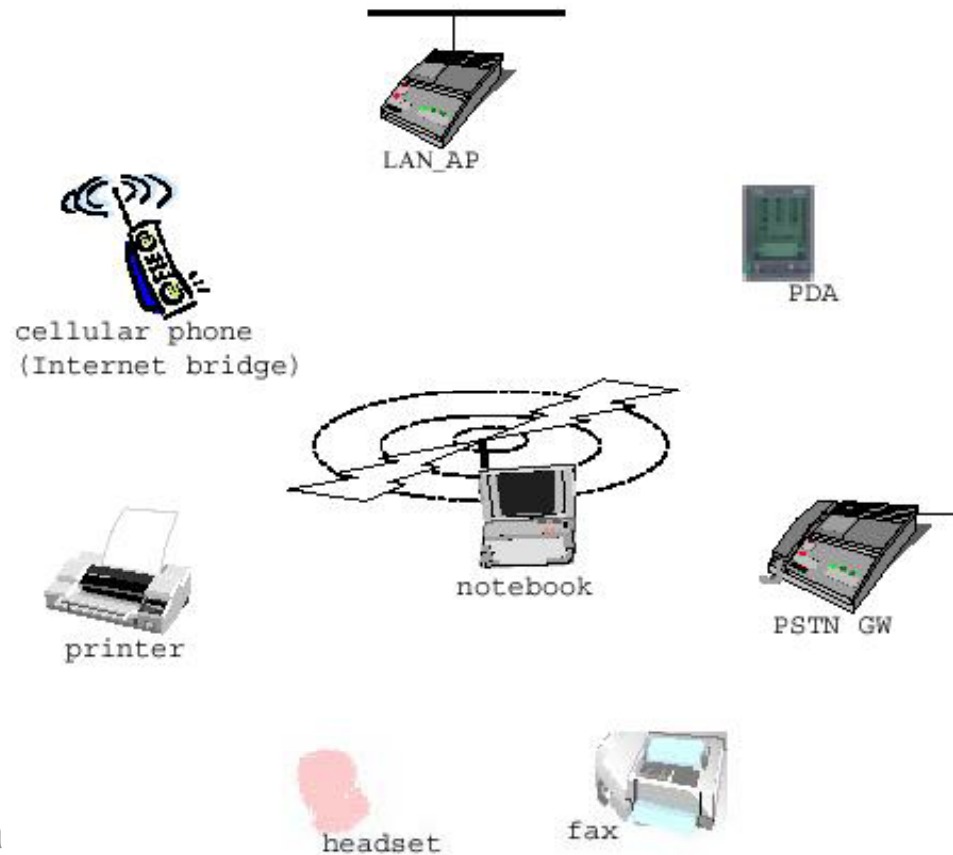

Basic Questions? Find your partners?



Connection Establishments
Scan, Page and Inquiry

Step1 Inquiry

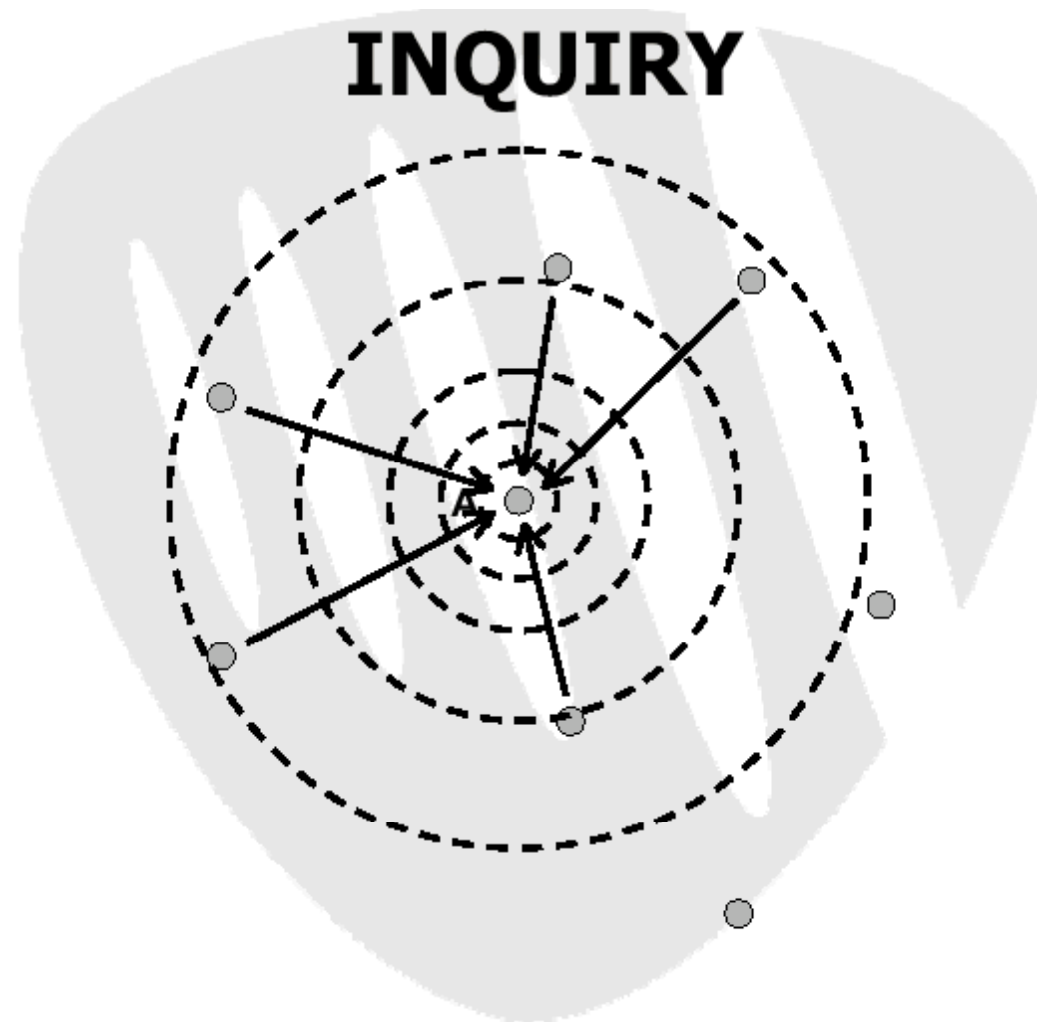

Centrally polling control

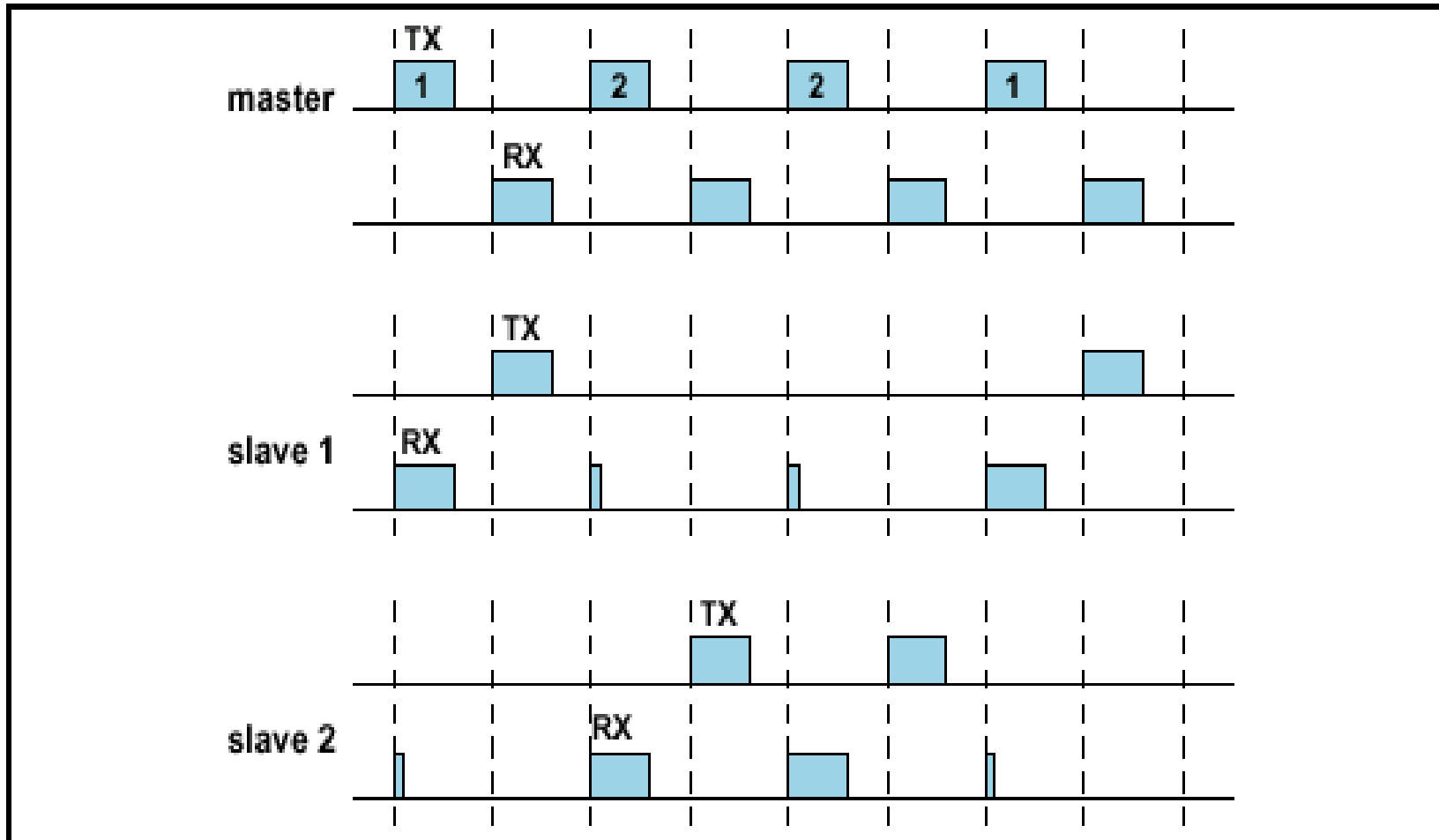

Multi Slot Packets

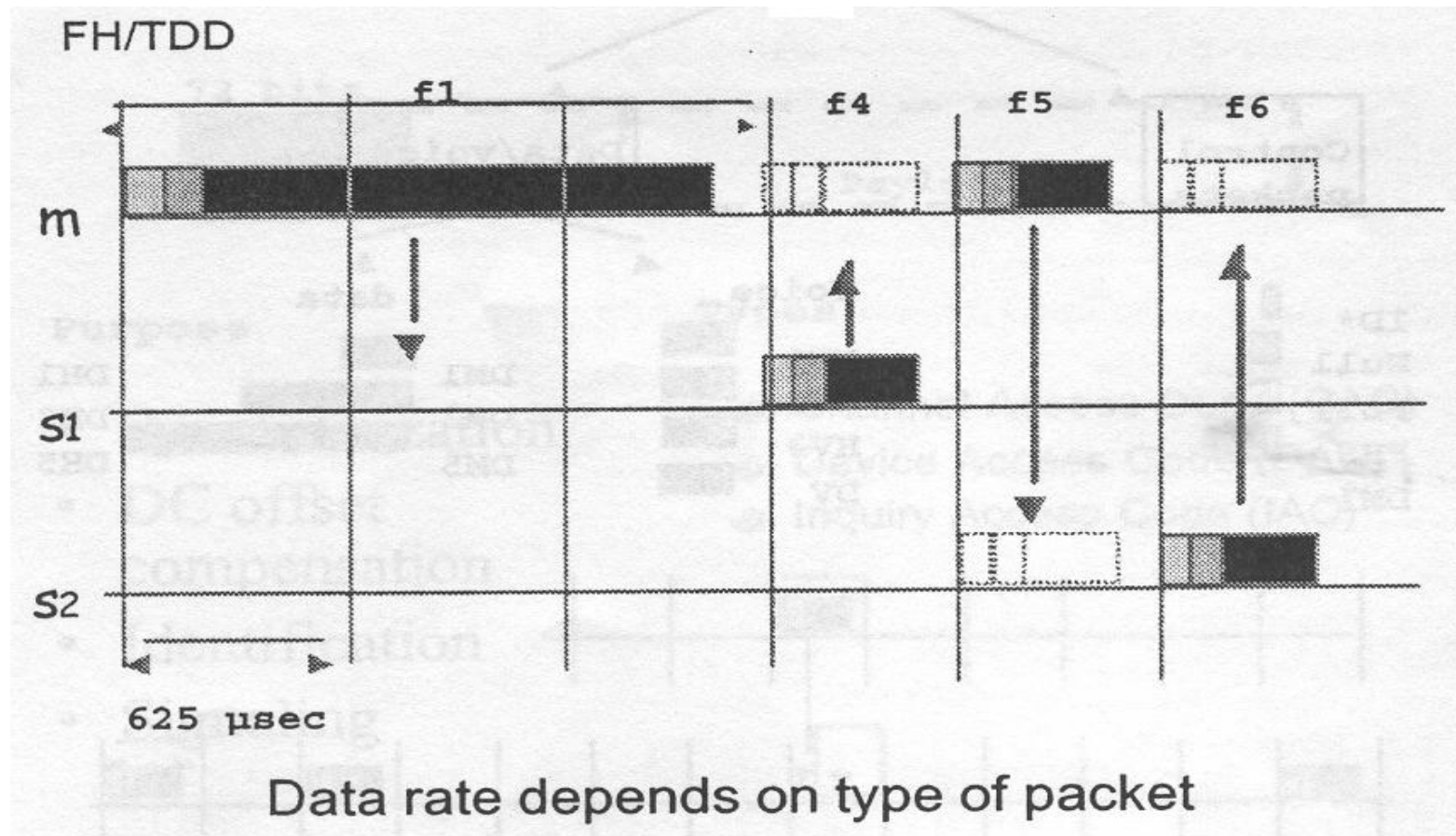

Physical Link Types

- ◆ **Synchronous Connection Oriented (SCO) Link**
 - slot reservation at intervals
- ◆ **Asynchronous Connection-less (ACL) Link**
 - Polling access method

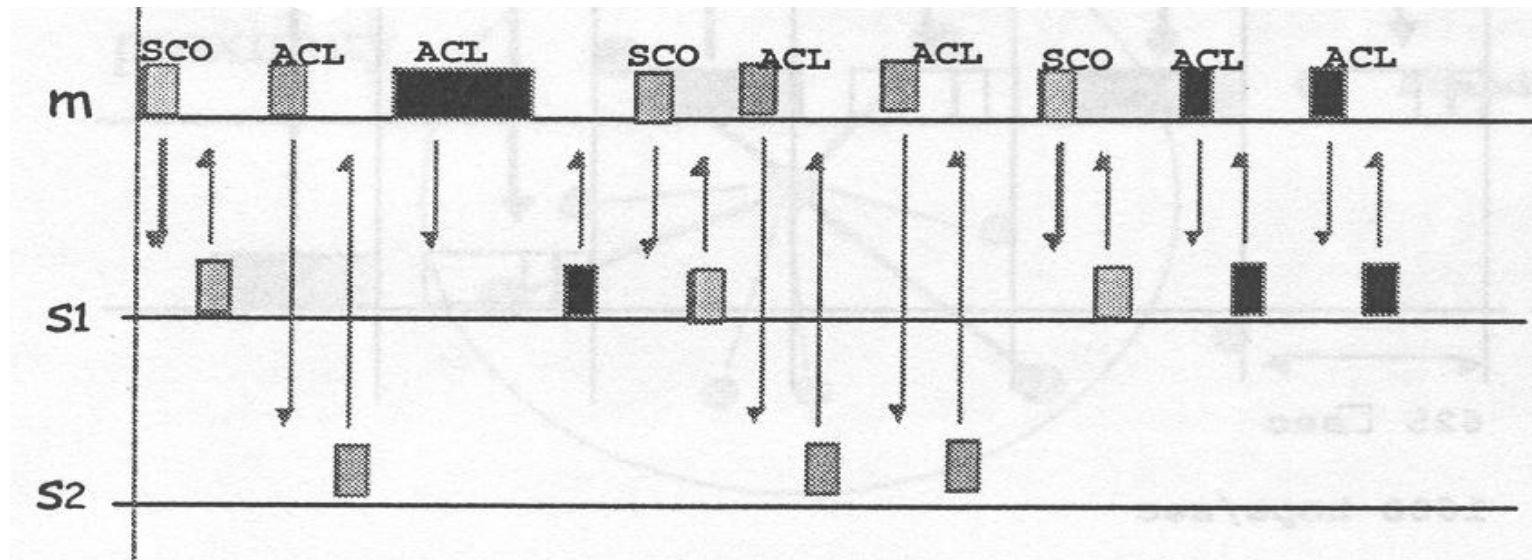

Overview of Bluetooth

- ◆ **Short range radio research**
 - Providing Ad hoc networking between cellular phones, notebook computer, and PDA, etc.

- ◆ **Bluetooth answers the need for short range wireless connectivity within three areas:**
 - Data and Voice access points
 - Cable replacement
 - Ad hoc networking

Overview of Bluetooth

- ◆ **Bluetooth radio**
 - operates in a globally available 2.4 GHz ISM band, ensuring communication compatibility worldwide.
 - Gross data rate is 1Mb/s.
- ◆ **Bluetooth baseband – mac layer of Bluetooth**
 - fast acknowledgement (1-bit piggyback ack)
 - frequency hopping scheme
 - A Time-Division Duplex scheme is used for full-duplex transmission
 - Transmissions centrally controlled by the master with polling scheme

Overview of Bluetooth

- ◆ **Bluetooth data rate**
 - Voice channel supports 64 kb/s synchronous (voice) link
 - asynchronous channel can support an asymmetric link of maximally 721 kb/s
 - maximally 432.6 kb/s for symmetric link
- ◆ **Bluetooth network**
 - A piconet contains a master and up to 7 slaves
 - Several piconets can be linked together, forming a scatternet
 - Each piconet is identified by a different frequency hopping sequence

Inquiry & Inquiry Scan

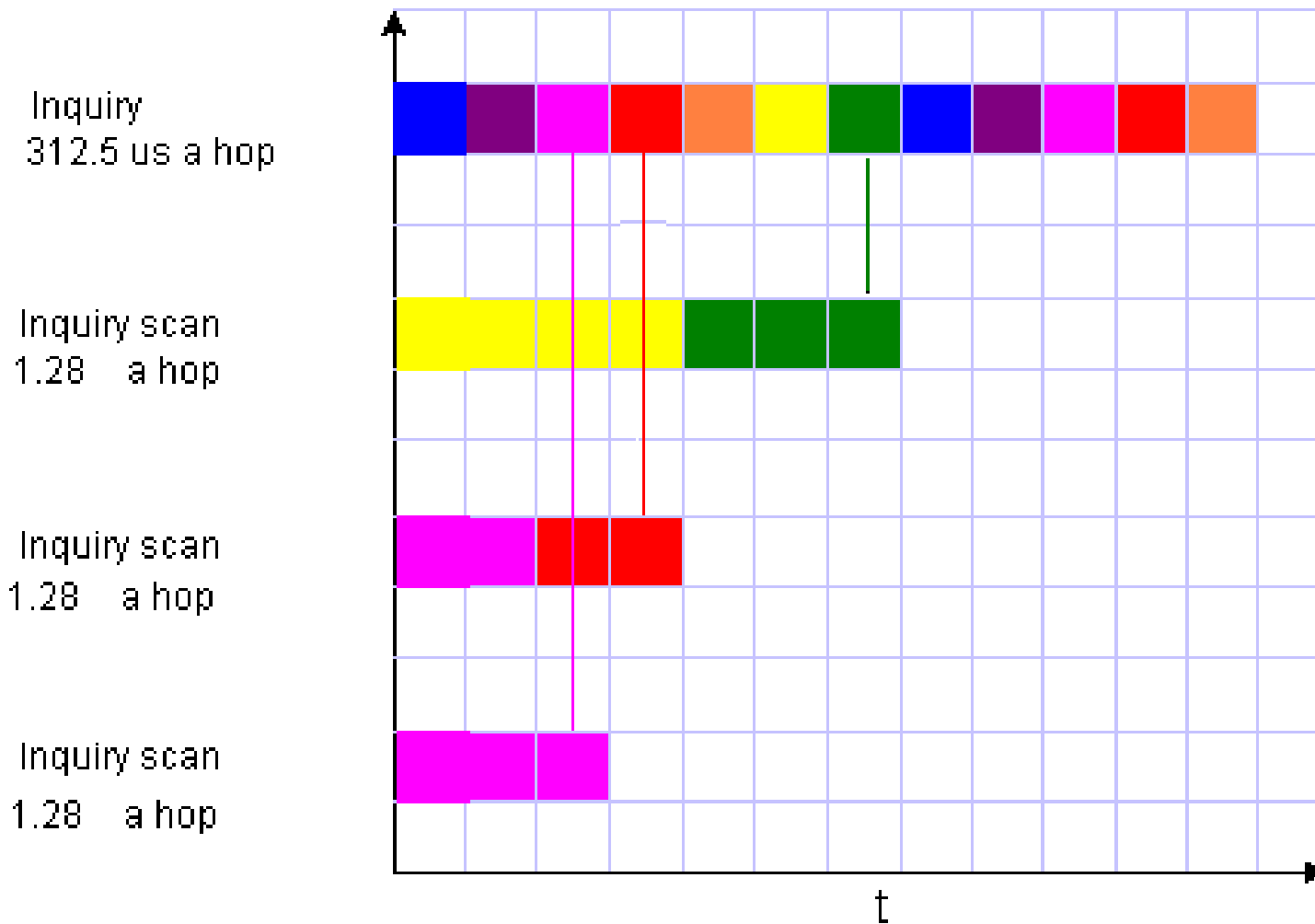

Step2 Page

CREATING A PICONET

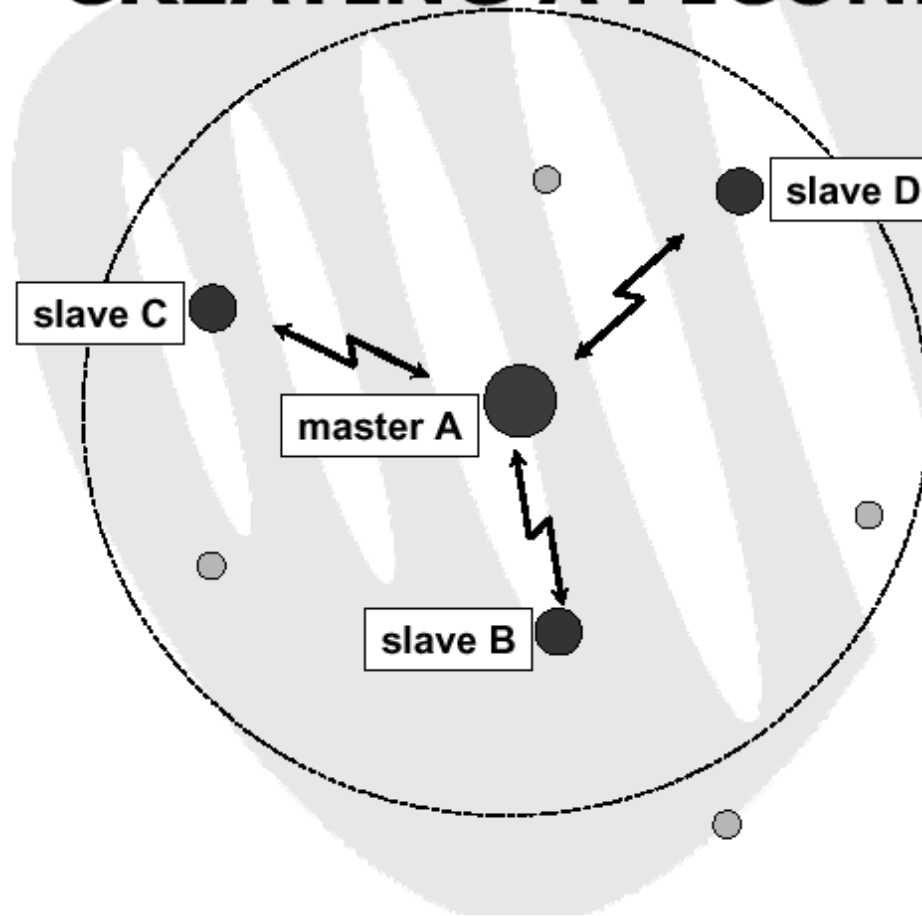

The Bluetooth asymmetric point to point connection establishment protocol

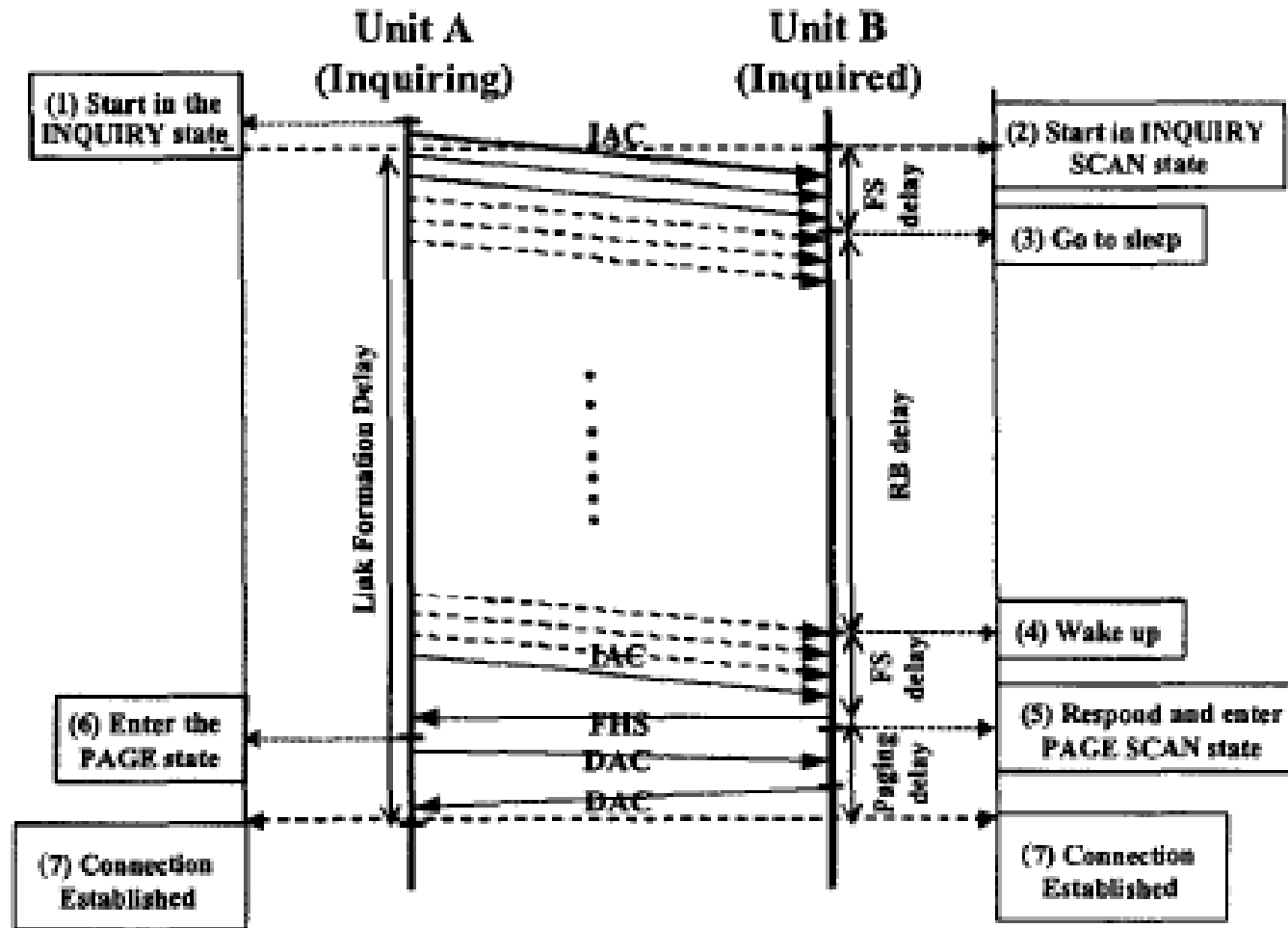

Piconet & Scatternet

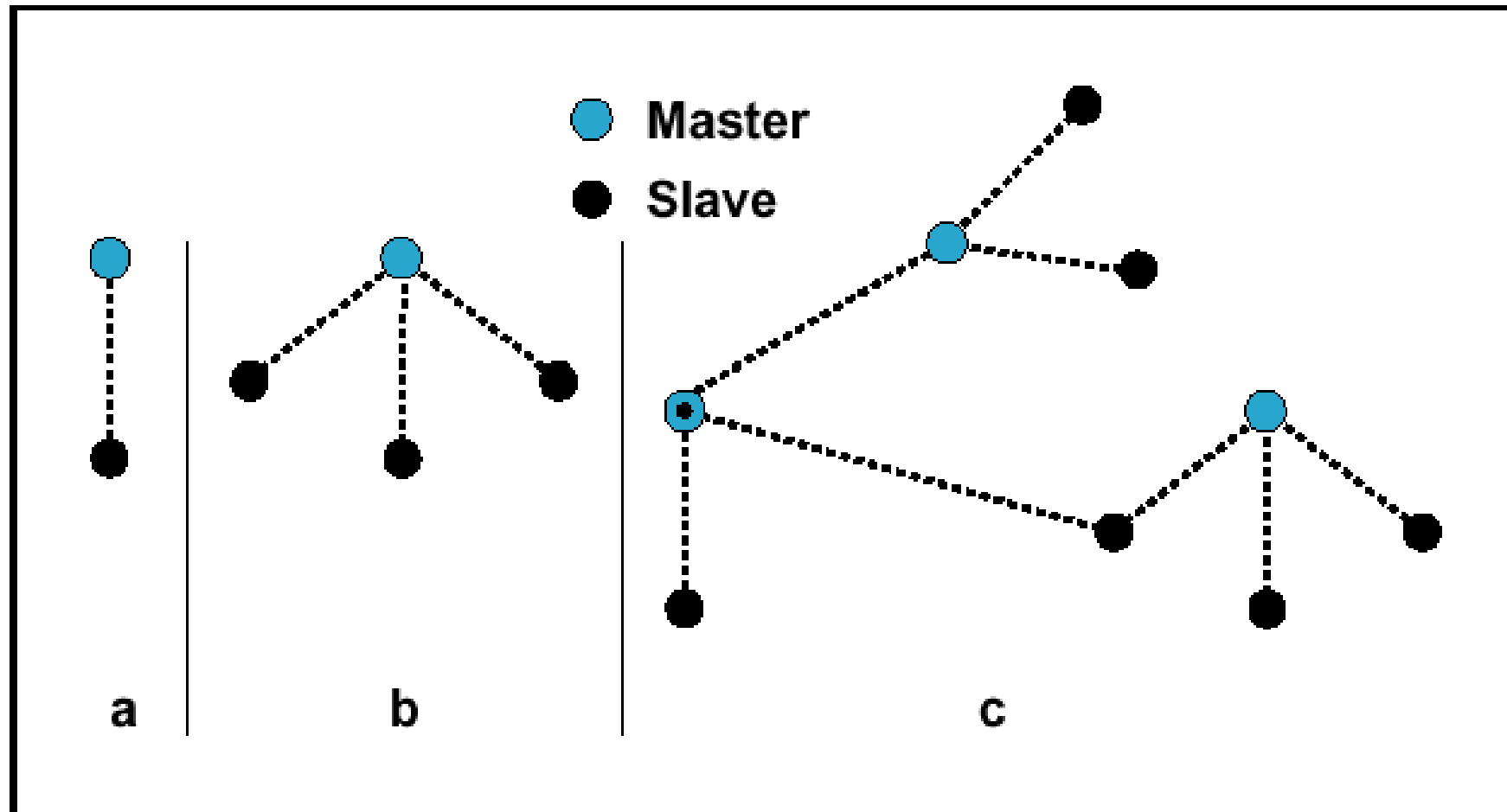

State diagram of Bluetooth

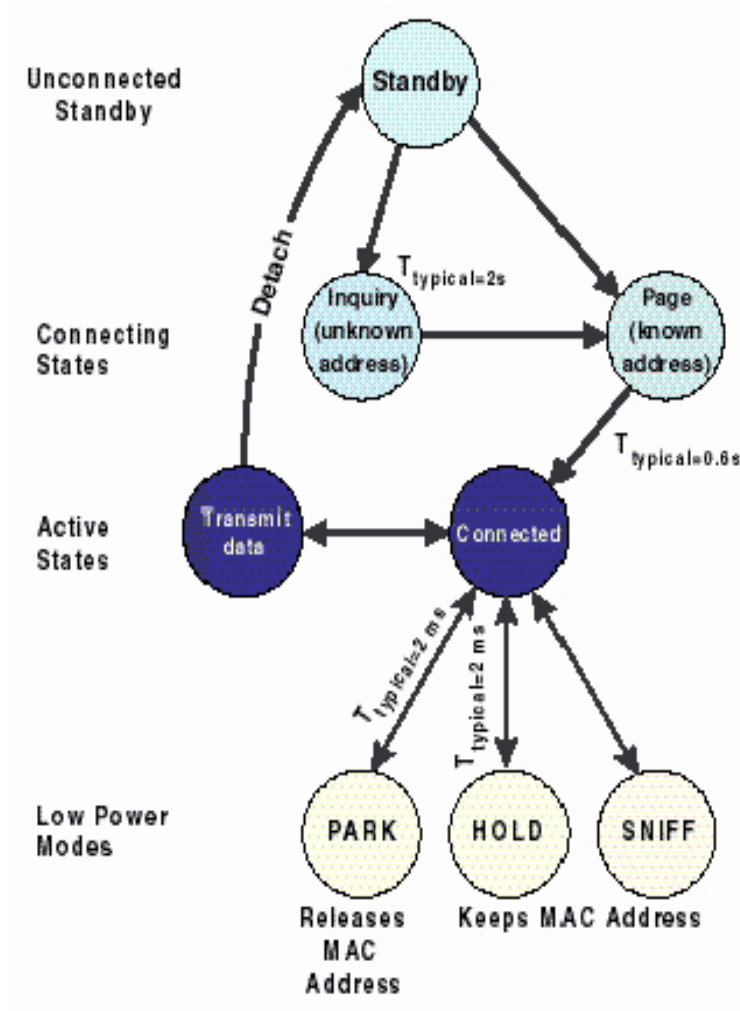

Protocol Stack of Bluetooth

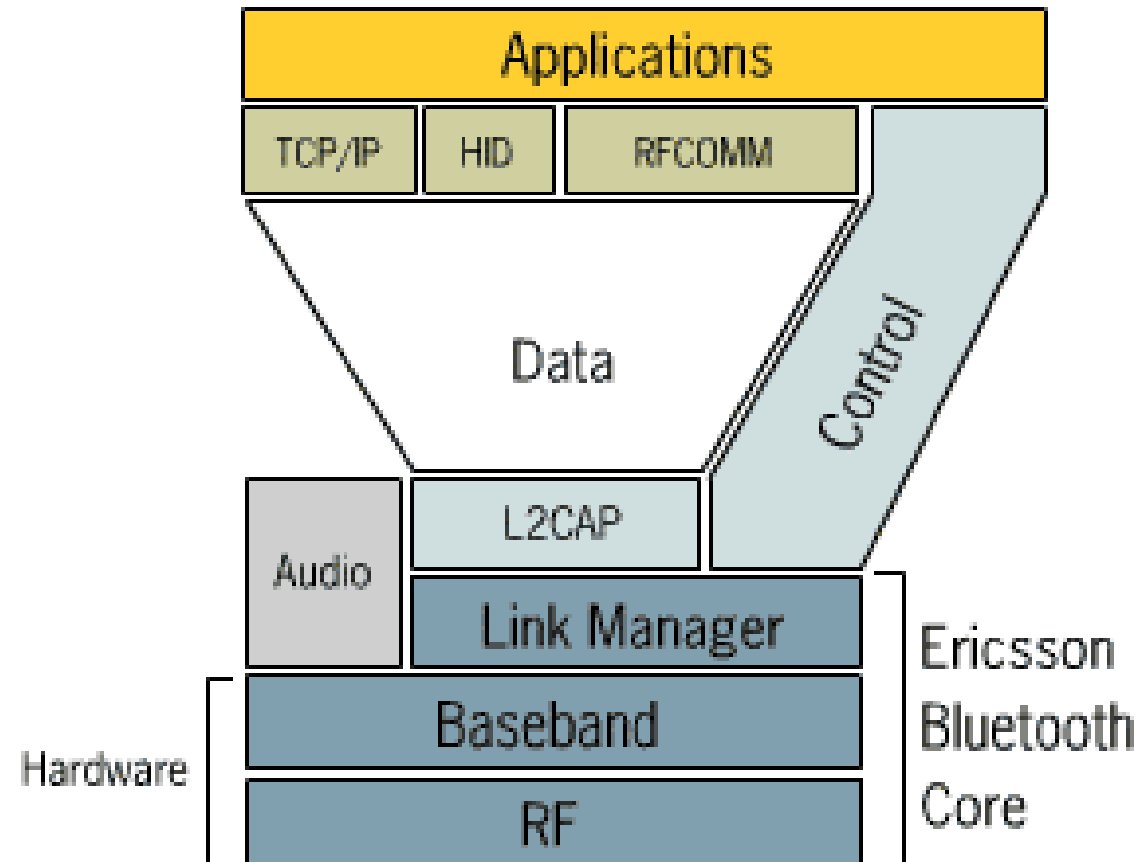

Scatternet establishment

◆ Start up procedure

- Enter Inquiry and Inquiry scan state in term for a period of time
- Discovering neighbors
- Arrange neighbors table(self id included) with device id by increasing order, therefore, each unit get a sequence number, we call this number as pseudo candidate sequence number, because the lack of communication channel between units; self device id should be at 8th notch or before 8th notch
- Enter paging frame

Network scenario

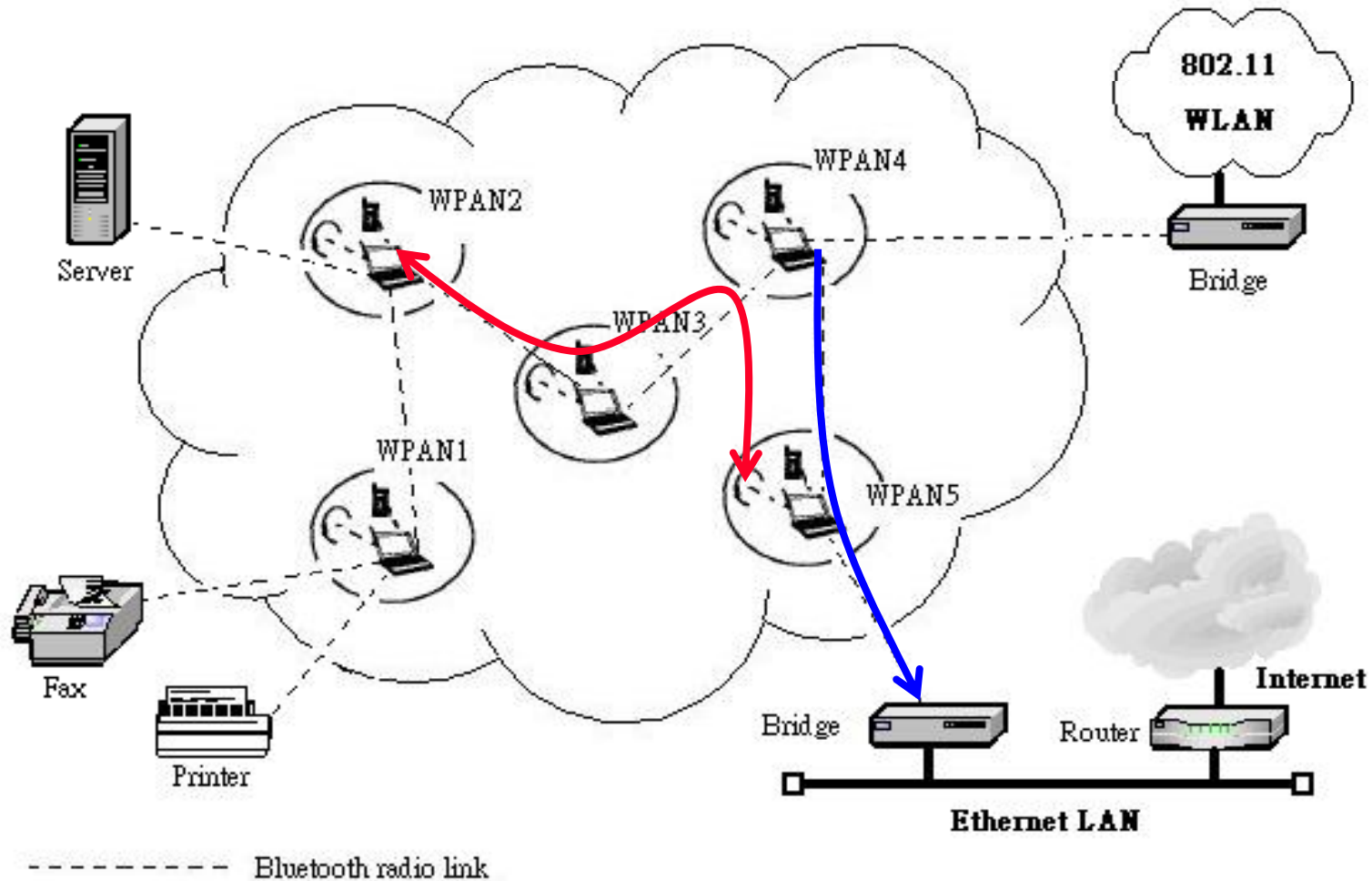

Bluetooth and UWB

UWB: Next Generation Technology for Wireless Personal Area Network



Definition of FCC

$$\text{fractional bandwidth} = \frac{2(f_H - f_L)}{f_H + f_L} > 0.25$$

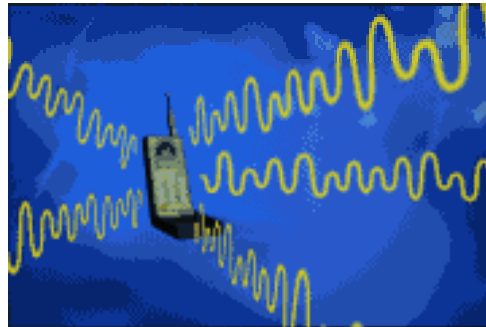

UWB vs. Narrow Band

Ultrawideband
Communication

Impulse
Modulation

Time-domain behavior

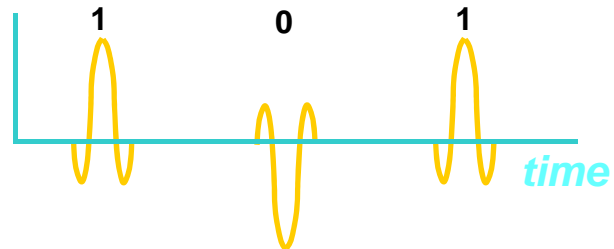

Frequency-domain behavior

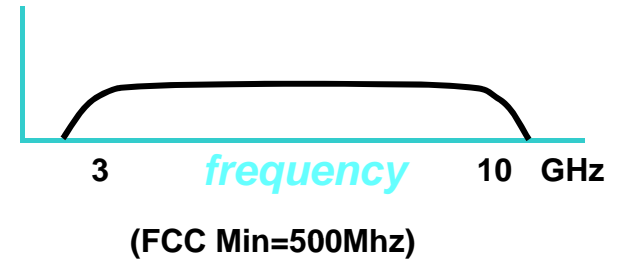

Narrowband
Communication

Frequency
Modulation

0 1 0 1

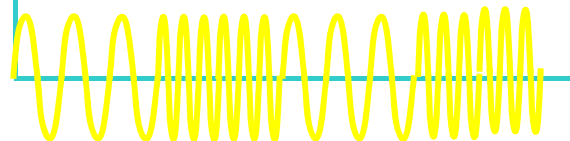

2.4

GHz



UWB Spectrum

- ◆ FCC ruling permits UWB spectrum overlay

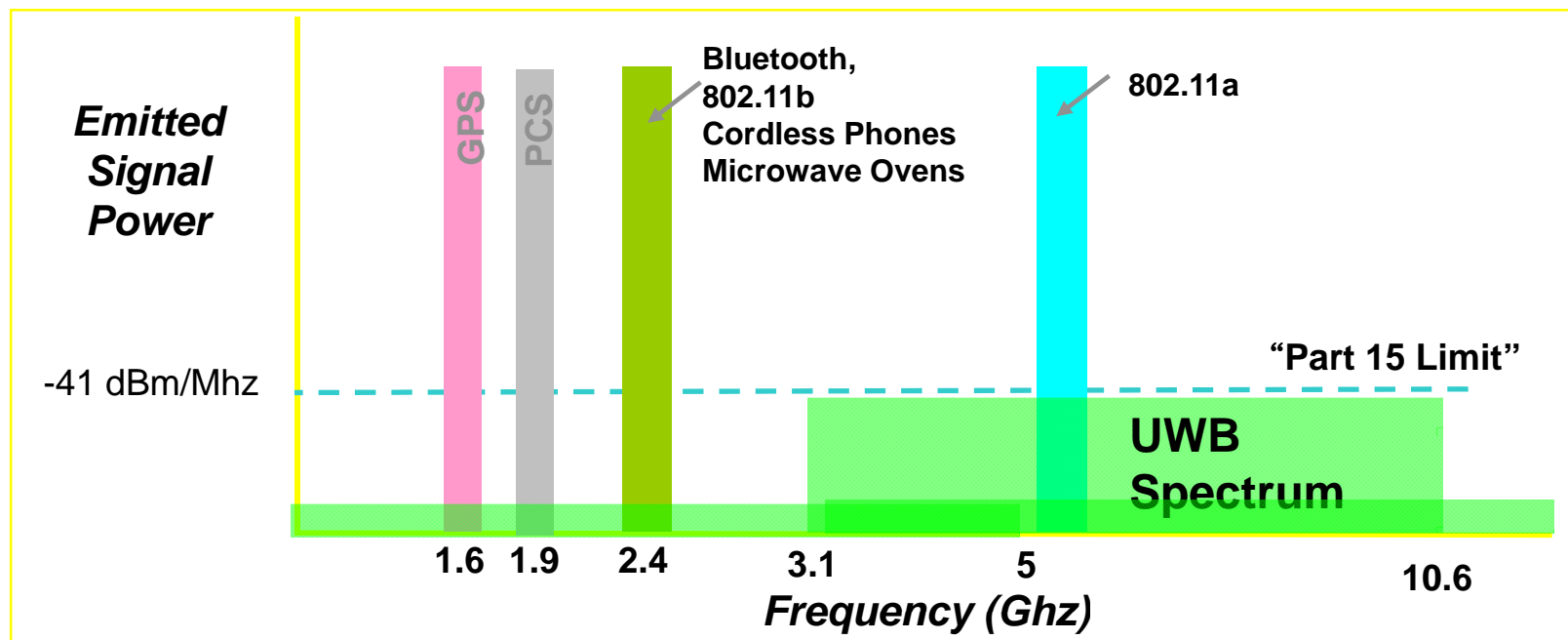

INTEL: Wireless USB (Home)

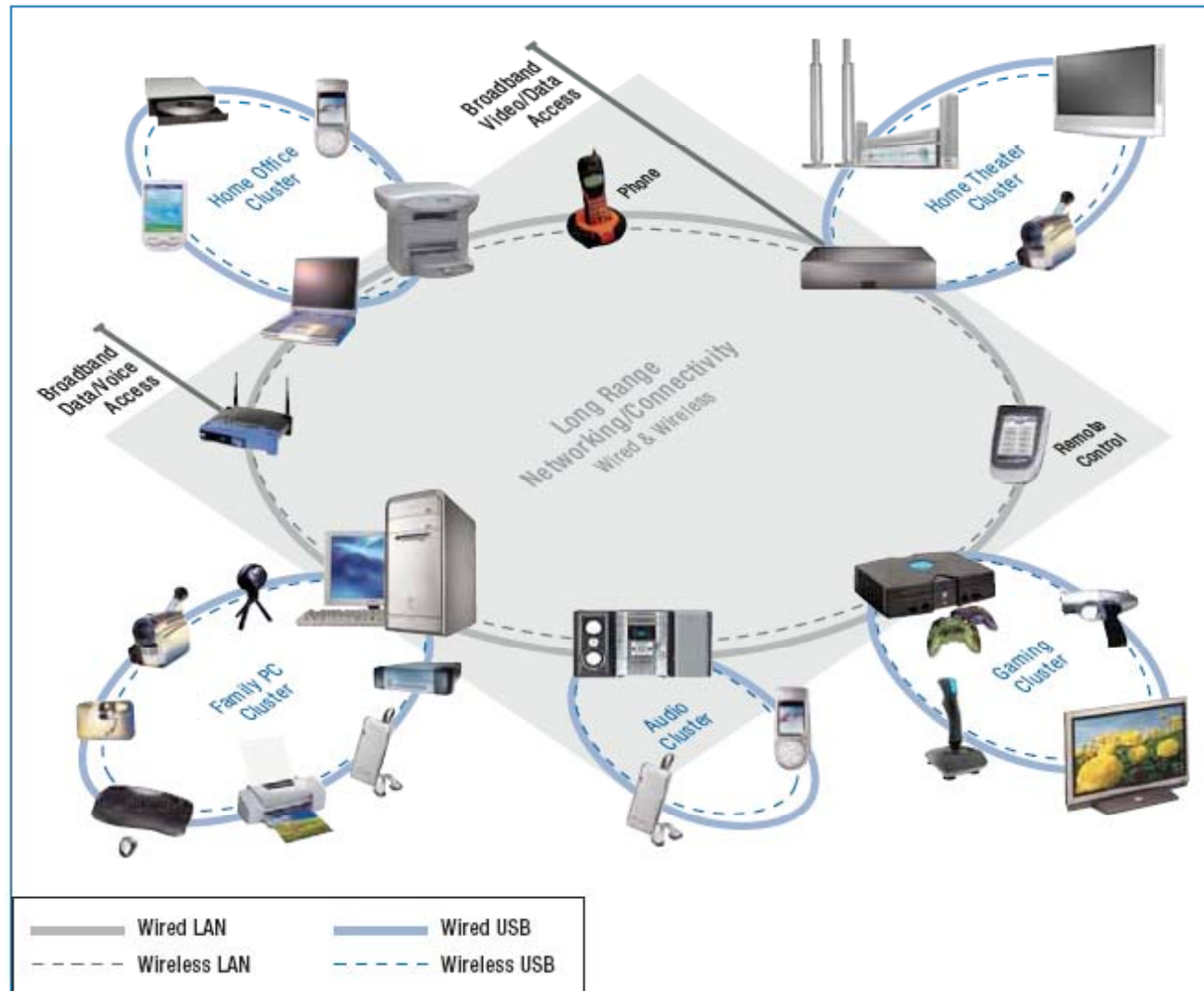

WiMedia Hybrid Network 'Personal Operating Space'

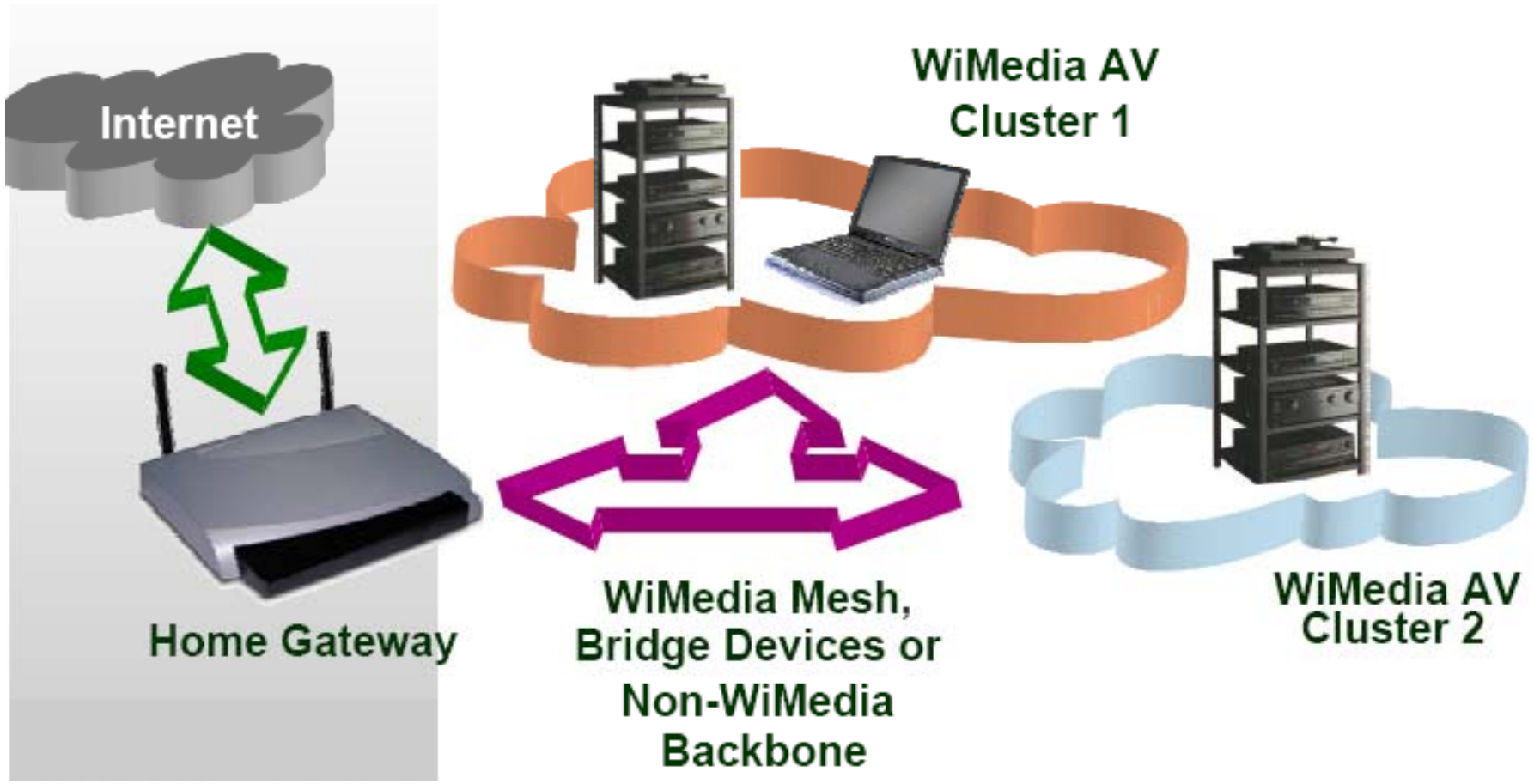

IEEE 802.11

IEEE 802.11 Protocol Entities

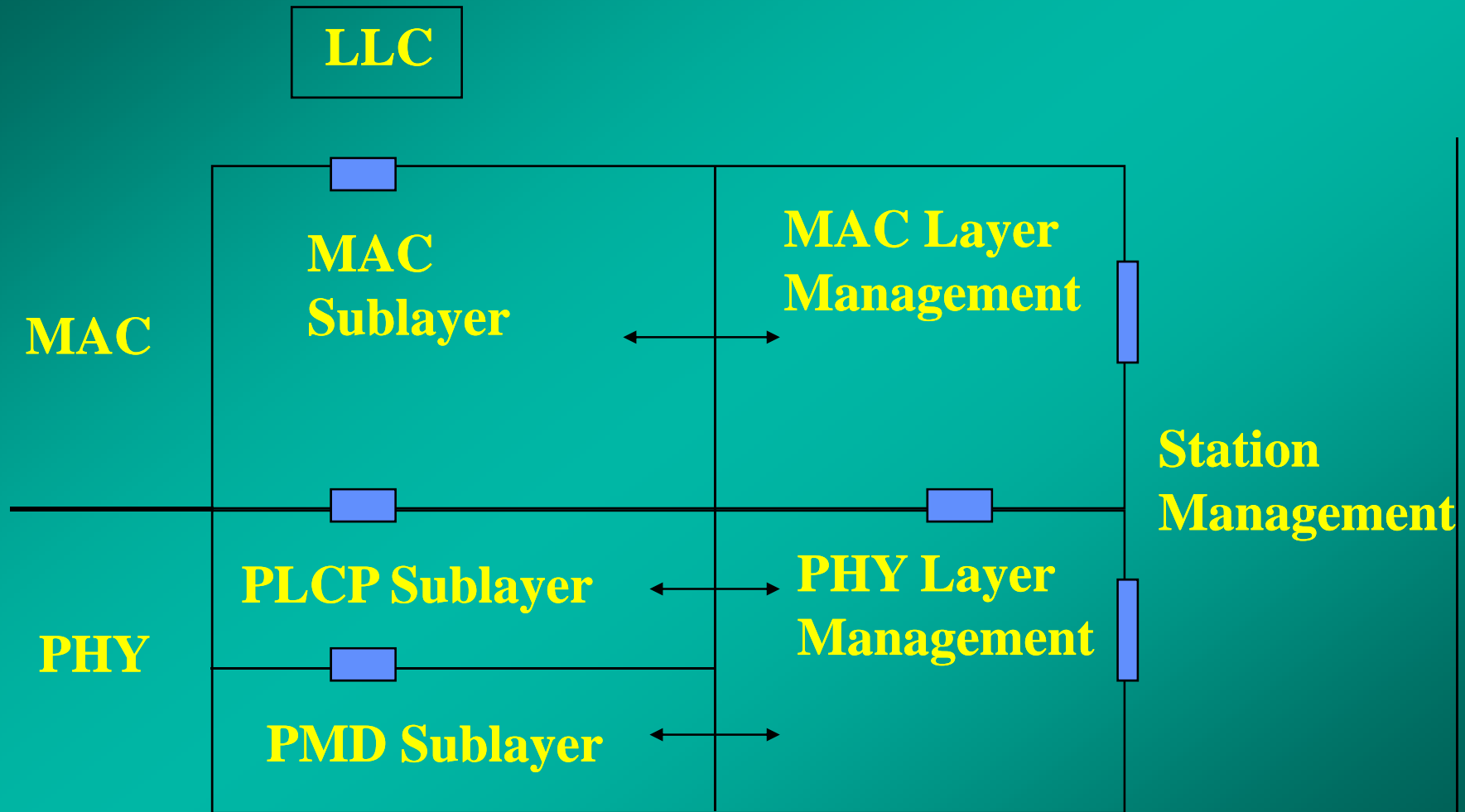

IEEE 802.11 Protocol Architecture



- ◆ MAC Entity
 - **basic access mechanism**
 - **fragmentation**
 - **encryption (RC4 PRNG Algo. 40 bit secret key)**
- ◆ MAC Layer Management Entity
 - **synchronization**
 - **power management**
 - **roaming**
 - **MAC MIB**
- ◆ Physical Layer Convergence Protocol (PLCP)
 - **PHY-specific, supports common PHY SAP**
 - **provides Clear Channel Assessment signal (carrier sense)**

IEEE 802.11 Protocol Architecture



- ◆ Physical Medium Dependent Sublayer (PMD)
 - **modulation and encoding**

- ◆ PHY Layer Management
 - **channel tuning**
 - **PHY MIB**

- ◆ Station Management
 - **interacts with both MAC Management and PHY Management**

名詞解釋

- ◆ **Basic Service Set (BSS) - is the fundamental building block of the IEEE 802.11 architecture. A BSS is defined as a group of stations that are under the direct control of a single coordination function , i.e. , a DCF or PCF .**

名詞解釋

- ◆ **Coordination Function (CF) - That logical function which determines when a station operating within a Basic Service Set transmits and receives via the wireless medium.**

IEEE 802.11 Wireless LAN Architecture

- ◆ **Ad Hoc Network (Independent Basic Service Set Network : IBSS Network)**
- ◆ **Infrastructure Network**

IEEE 802.11 Configurations - Independent

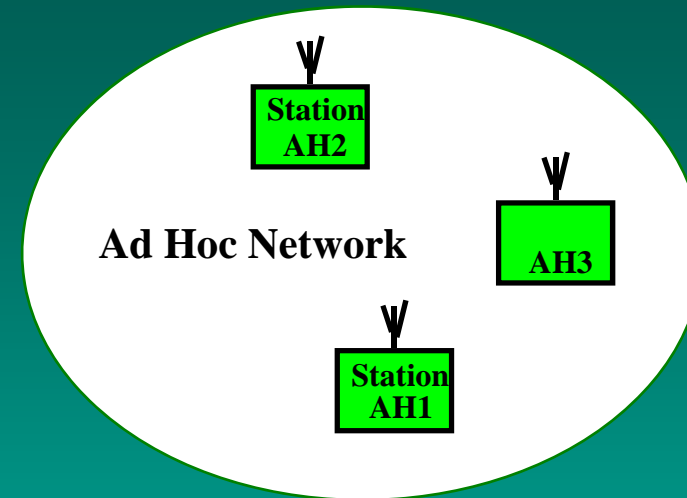

◆ Independent

- one Basic Service Set - BSS
- Ad Hoc network
- direct communication
- limited coverage area

IEEE 802.11 Configurations - Infrastructure

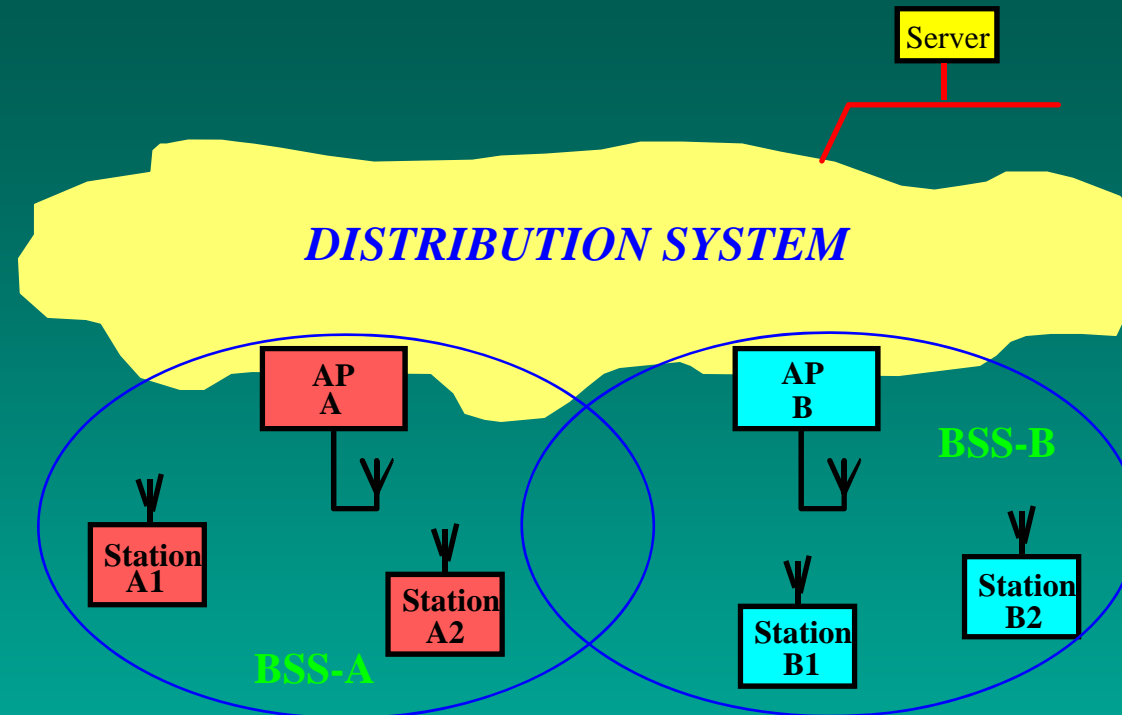

- ◆ Infrastructure
 - Access Points and stations
- ◆ Distribution System interconnects Multiple Cells via Access Points to form a single Network.
 - extends wireless coverage area

Distribution System

Used to interconnect wireless cells

multiple BSSs connected together form an ESS, Extended Service Set

Not part of 802.11 standard

could be bridged IEEE LANs, wireless, other networks

Distribution System Services are defined

Access Point

Stations select an AP and Associate with it

Support roaming

Provide other functions

time synchronization (beaconing)

power management support

point coordination function

Traffic typically (but not always) flows through AP

direct communication possible

Services Provided by MAC

- ◆ **Distribution System Service** - Divided into six kinds of service. Let data be received or sent between station and station.
- ◆ **Station Service** - Divided into three kinds of service. Controlling access and privacy of IEEE 802.11 Wireless Network.

Distribution System Services

- ◆ **Distribution** - Send data , which is in distribution system , to correct address
- ◆ **Integration** - Exchange data between Distribution System and existent wired network

Distribution System Services

◆ Association

Mobility of Station

- **No-Transition**
 - ◆ **Static**
 - ◆ **Local Movement**
- **BSS-Transition**
- **ESS-Transition**

Stations must establish connection with AP before sending data to it. This action is provided by Association service.

Distribution System Services

- ◆ Reassociation

Requested by station

- Move a current association from one AP to another
- Change connection type

Distribution System Services

◆ Deassociation

Requested by station or AP

- **Stations leave the wireless network**
- **AP close or can't provide some services**

Station or AP can't refuse Deassociation sent by the other

Distribution System Services

- ◆ MSDU delivery

Frames received or sent between stations and stations is provided by this service

- ◆ MSDU - MAC Service Data Unit

Station Service

- ◆ Authentication
 - **Open System**
 - **Shared Key**
- ◆ Deauthentication - When Authentication is cancelled , Association will be cancelled at the same time
- ◆ Privacy - The 802.11 embeds the WEP (Wired Equivalent Privacy) mechanism within the MAC that covers station-to-station transmission

Relationships between Services

There two state variable (Authentication , Association) create three station states :

- ◆ Initial State , Unauthenticated , Unassociated
- ◆ Authenticated , not Associated
- ◆ Authenticated and Associated

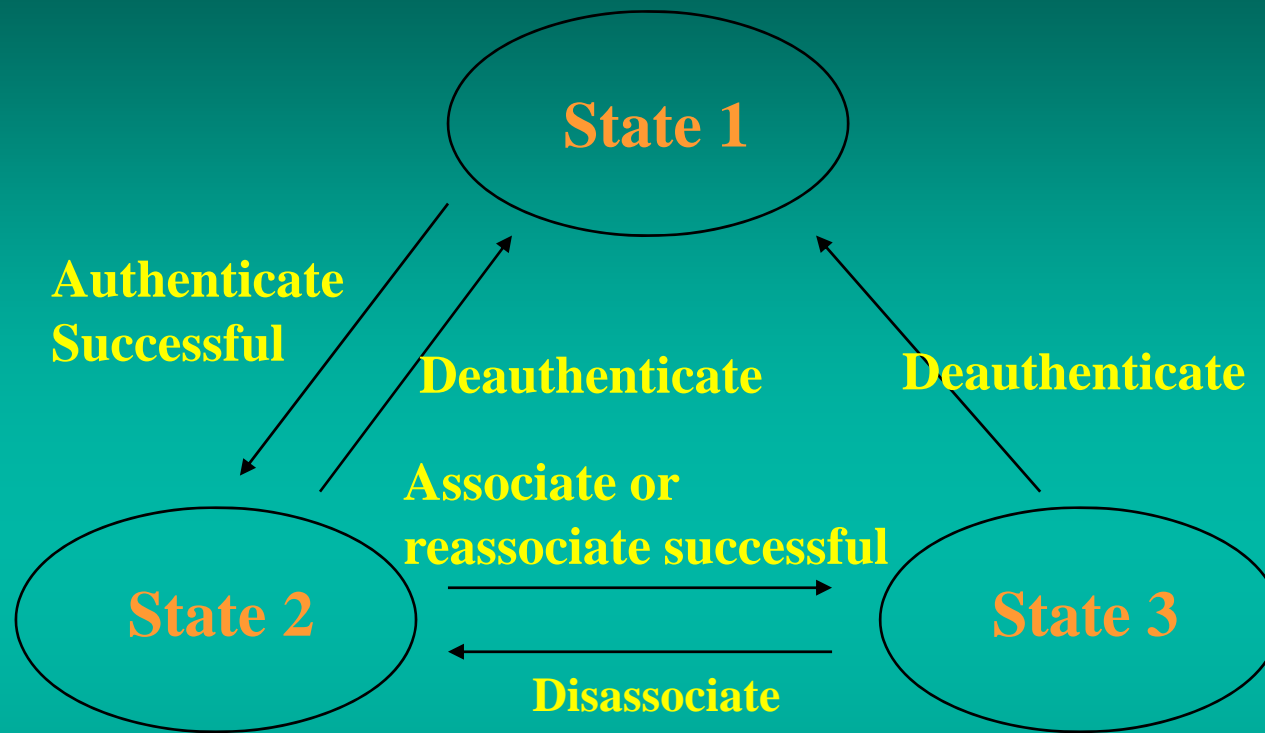

Relations Between State Variables and Services

MAC Frame Formats

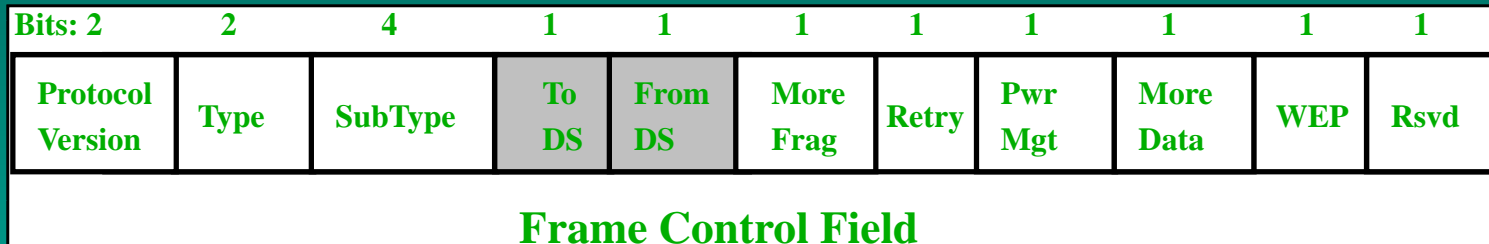
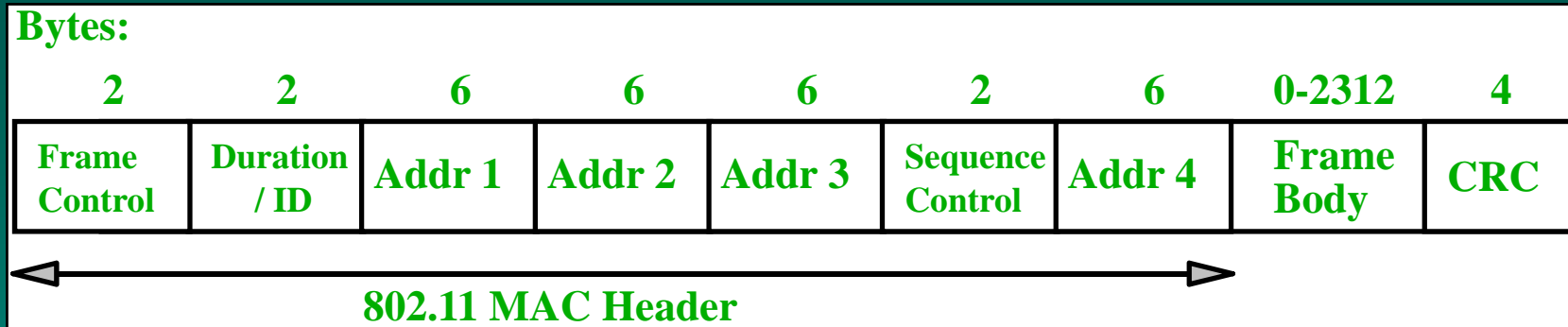

- ◆ MAC Header format differs per Type:
 - **Control Frames (several fields are omitted)**
 - **Management Frames**
 - **Data Frames**
- ◆ Includes Sequence Control Field for filtering of duplicate caused by ACK mechanism.

Address Field Description



To DS	From DS	Address 1	Address 2	Address 3	Address 4
0	0	DA	SA	BSSID	N/A
0	1	DA	BSSID	SA	N/A
1	0	BSSID	SA	DA	N/A
1	1	RA	TA	DA	SA

- ◆ Addr 1 = All stations filter on this address.
- ◆ Addr 2 = Transmitter Address (TA)
 - **Identifies transmitter to address the ACK frame to.**
- ◆ Addr 3 = Dependent on *To* and *From DS* bits.
- ◆ Addr 4 = Only needed to identify the original source of *WDS (Wireless Distribution System)* frames.

CSMA/CA Protocol

- ◆ IEEE 802.11 use CSMA/CA protocol
- ◆ IEEE 802.11 provide two categories of basic access method
 - **Distributed Coordination Function (DCF)**
 - **Pointed Coordination Function (PCF)**
 - ◆ **Provide Time Bounded Service**

Optional Point Coordination Function (PCF)

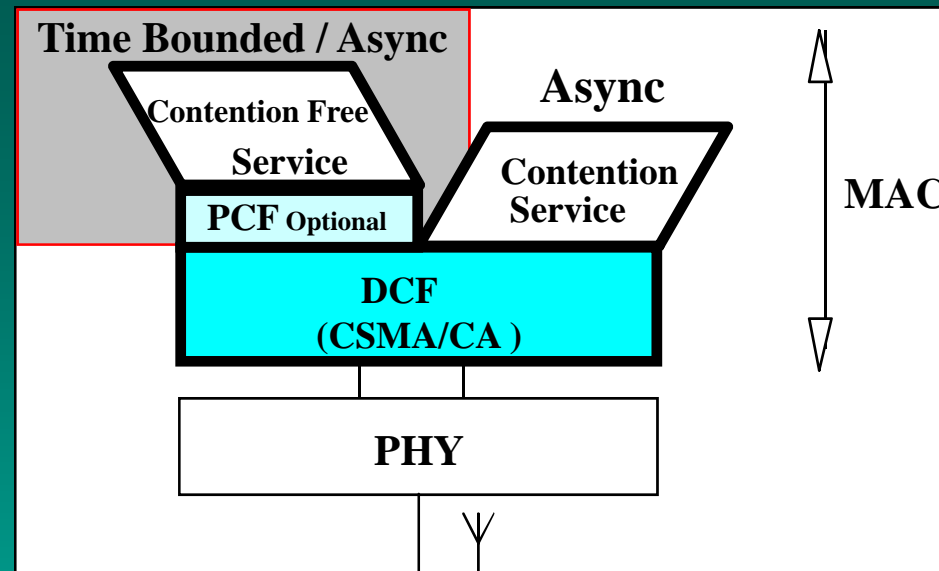

- **Contention Free Service uses Point Coordination Function (PCF) on a DCF Foundation.**
 - PCF can provide lower *transfer delay* variations to support *Time Bounded Services*.
 - Async Data, Voice or mixed implementations possible.
 - Point Coordinator resides in AP.
- **Coexistence between Contention and optional Contention Free does not burden the implementation.**

Distributed Coordination Function

- ◆ Priority access to the wireless medium is controlled through the use of Inter-Frame Space (IFS) time intervals between the transmission of frames. Three IFS intervals are specified in the standard.
 - **Short-IFS (SIFS)**
 - **Point Coordination Function-IFS (PIFS)**
 - **Distributed Coordination Function-IFS (DIFS)**

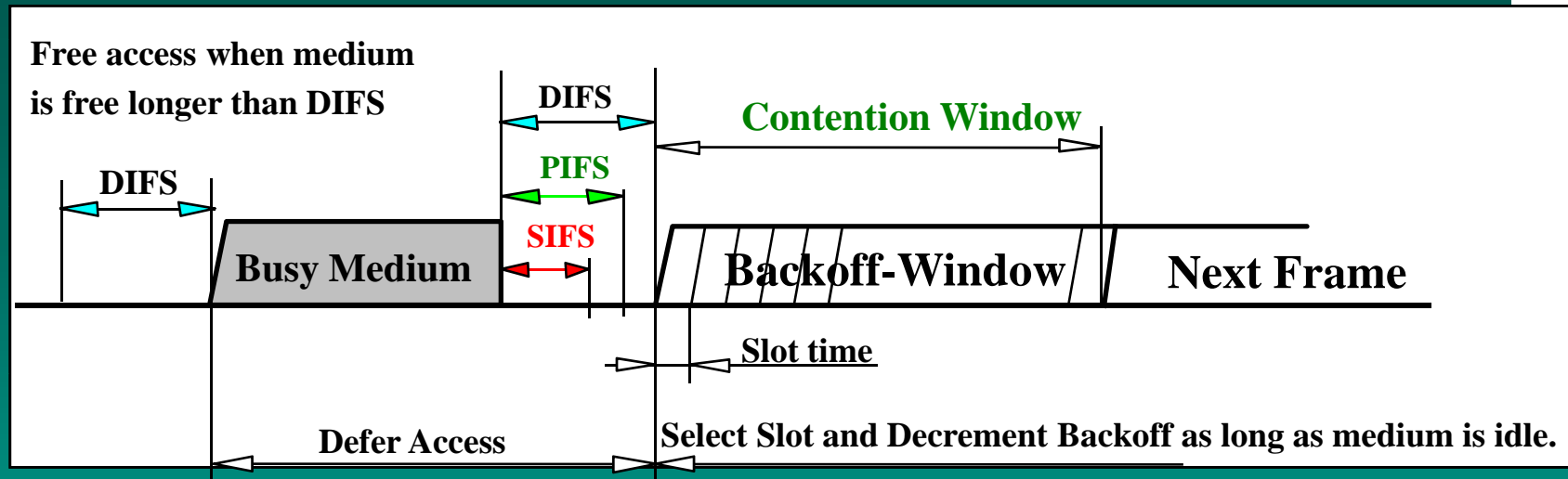

- ◆ $\text{Backoff Time} = \text{INT}(\text{CW} * \text{Random}()) * \text{Slot Time}$

CW = An integer between CWmin and CWmax

Random() = random number between 0 and 1

Slot Time = Transmitter turn-on delay +
 medium propagation delay +
 medium busy detect response time and is
 PHY dependent

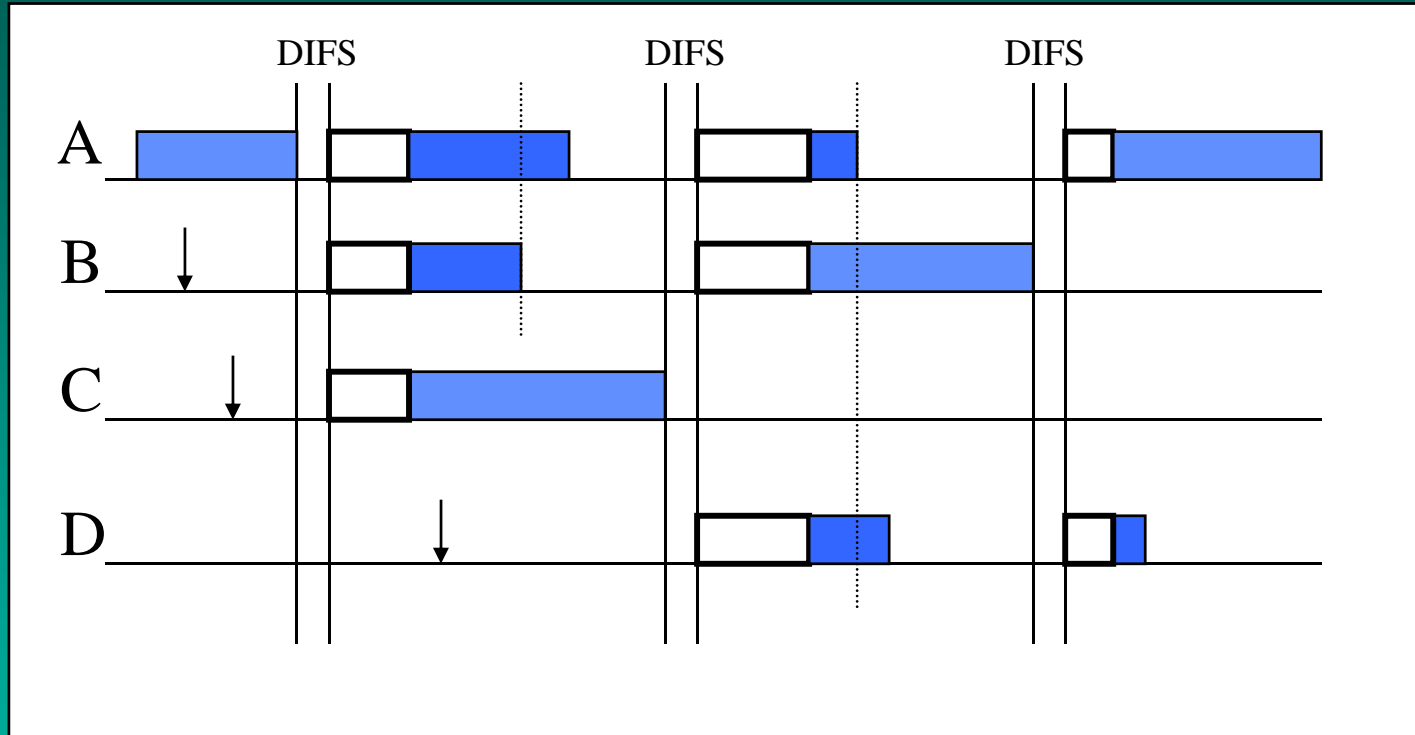

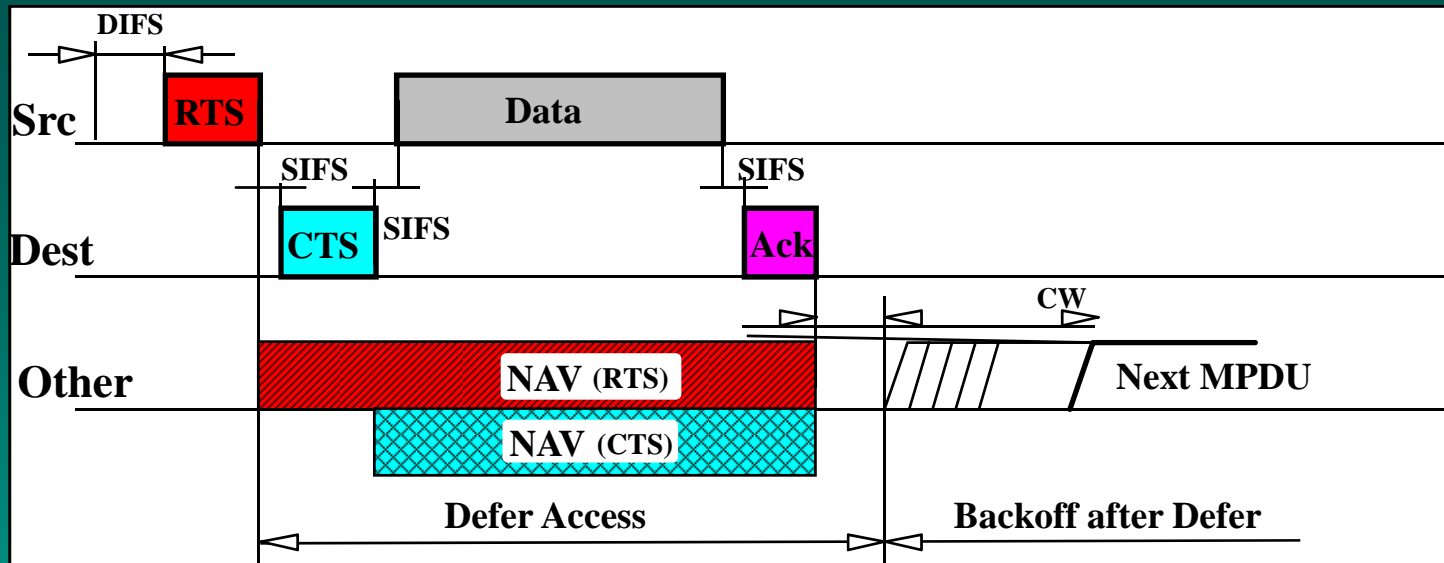

- *Duration* field in RTS and CTS frames distribute *Medium Reservation* information which is stored in a *Network Allocation Vector (NAV)*.
- Defer on either NAV or "CCA" indicating *Medium Busy*.
- Use of RTS / CTS is optional but must be implemented.

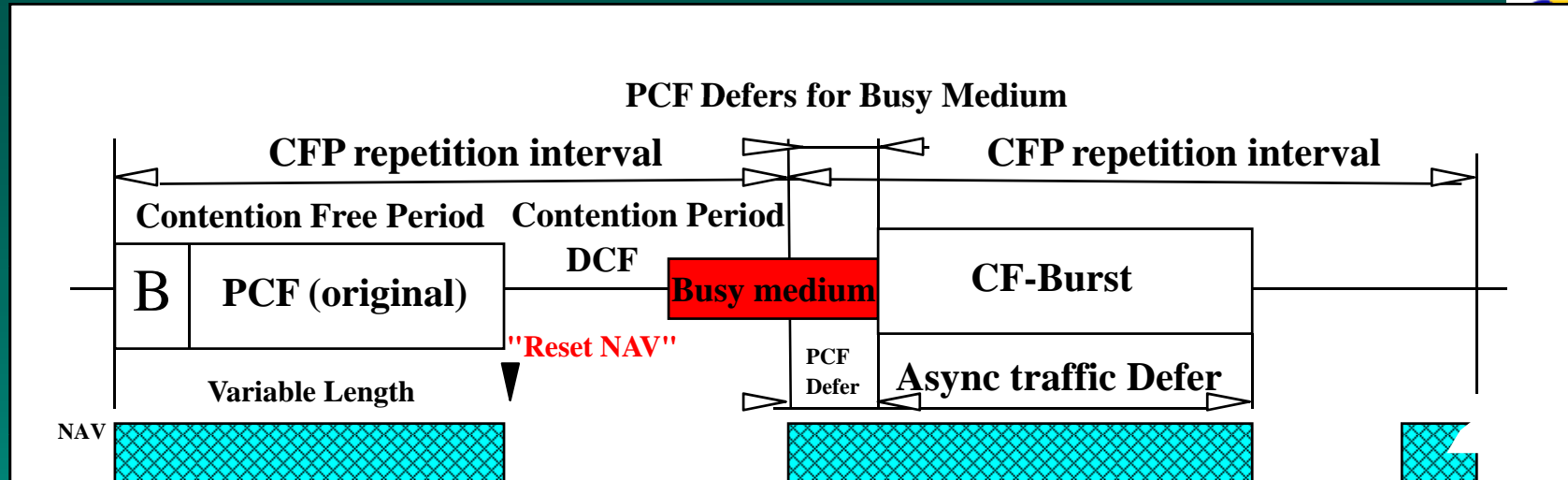

- Alternating *Contention Free* and *Contention* operation under PCF control.
- NAV prevents *Contention* traffic until reset by the last PCF transfer.
 - So variable length *Contention Free* period per interval.
- Both PCF and DCF defer to each other causing PCF Burst start variations.

PCF Burst

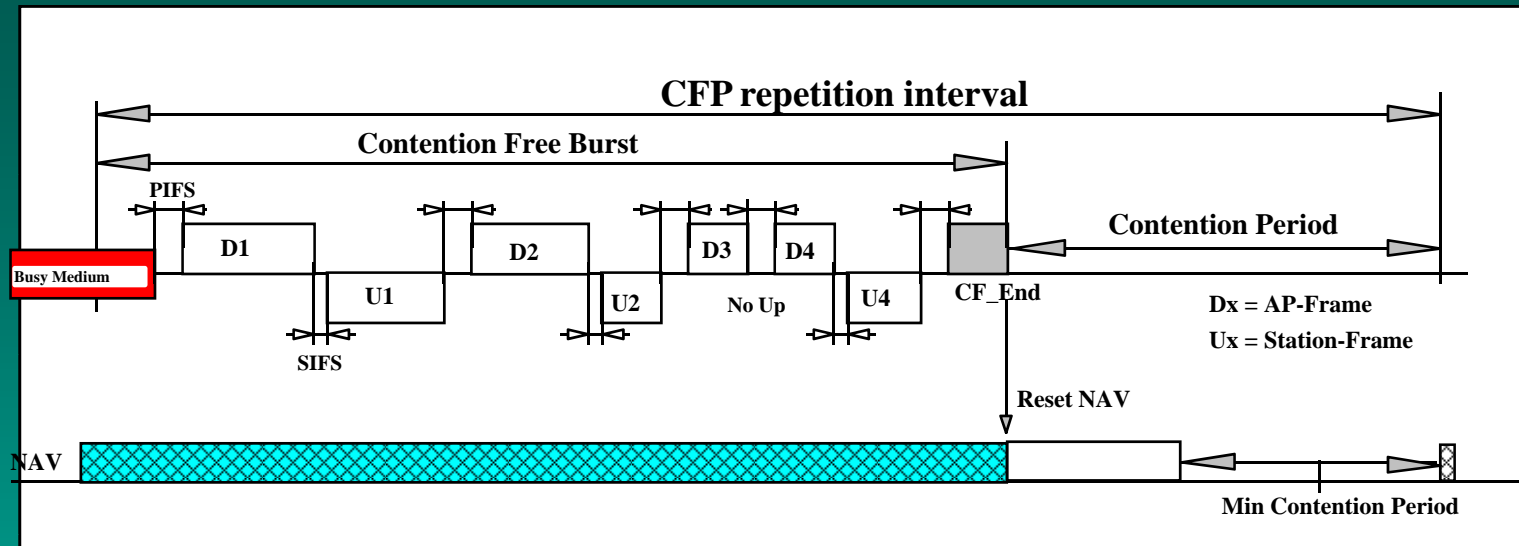

- CF-Burst by Polling bit in CF-Down frame.
- Immediate response by Station on a CF_Poll.
- Stations to maintain NAV to protect CF-traffic.
- Responses can be variable length.
- Reset NAV by last (CF_End) frame from AP.
- "ACK Previous Frame" bit in Header.

Fragmentation

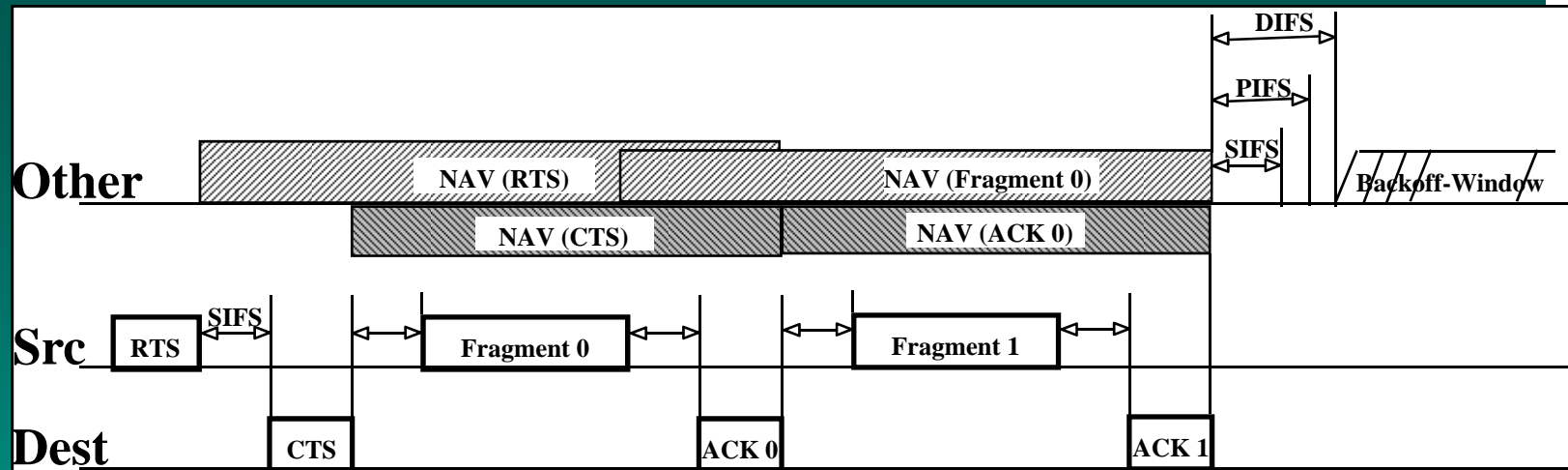

- ◆ Burst of Fragments which are individually acknowledged.
 - **For Unicast frames only.**
- ◆ Random backoff and retransmission of failing fragment when no ACK is returned.
- ◆ *Duration* information in data fragments and Ack frames causes NAV to be set, for medium reservation mechanism.

Power Management in IEEE 802.11

Two types of power management

- ◆ Power management in an infrastructure network.
- ◆ Power management in an IBSS.

In an infrastructure network

- ◆ **STAs changing Power Management mode shall inform the AP of this fact using the Power Management bits within the Frame Control field of transmitted frames.**
- ◆ **The STAs that currently have buffered MSDUs within the AP are identified in a *traffic indication map* (TIM), which shall be included as an element within all beacons generated by the AP.**
- ◆ **A STA shall determine that an MSDU is buffered for it by receiving and interpreting a TIM.**

Cont.

- ◆ **STAs operating in PS modes shall periodically listen for beacons, as determined by the STA's ListenInterval and ReceiveDTIMs parameters.**
- ◆ **If any STA in its BSS is in PS mode, the AP shall buffer all broadcast and multicast MSDUs and deliver them to all STAs immediately following the next Beacon frame containing a *delivery TIM* (DTIM) transmission.**

STA Power Management modes

Active mode or AM	STA may receive frames at any time. In Active mode, a STA shall be in the Awake state. A STA on the polling list of a PCF shall be in Active mode for the duration of the CFP.
Power Save or PS	STA listens to selected beacons (based upon the ListenInterval parameter of the MLME-Associate.request primitive) and sends PS-Poll frames to the AP if the TIM element in the most recent beacon indicates a directed MSDU buffered for that STA. The AP shall transmit buffered directed MSDUs to a PS STA only in response to a PS-Poll from that STA, or during the CFP in the case of a CF-Pollable PS STA. In PS mode, a STA shall be in the Doze state and shall enter the Awake state to receive selected beacons, to receive broadcast and multicast transmissions following certain received beacons, to transmit, and to await responses to transmitted PS-Poll frames or (for CF-Pollable STAs) to receive contention-free transmissions of buffered MSDUs.

AP TIM transmissions

- ◆ **The TIM shall identify the STAs for which traffic is pending and buffered in the AP.**
- ◆ **Every STA is assigned an Association ID code (AID) by the AP as part of the association process.**
- ◆ **AID 0 (zero) is reserved to indicate the presence of buffered broadcast/multicast MSDUs.**

Infrastructure power management operation (no PCF operating)

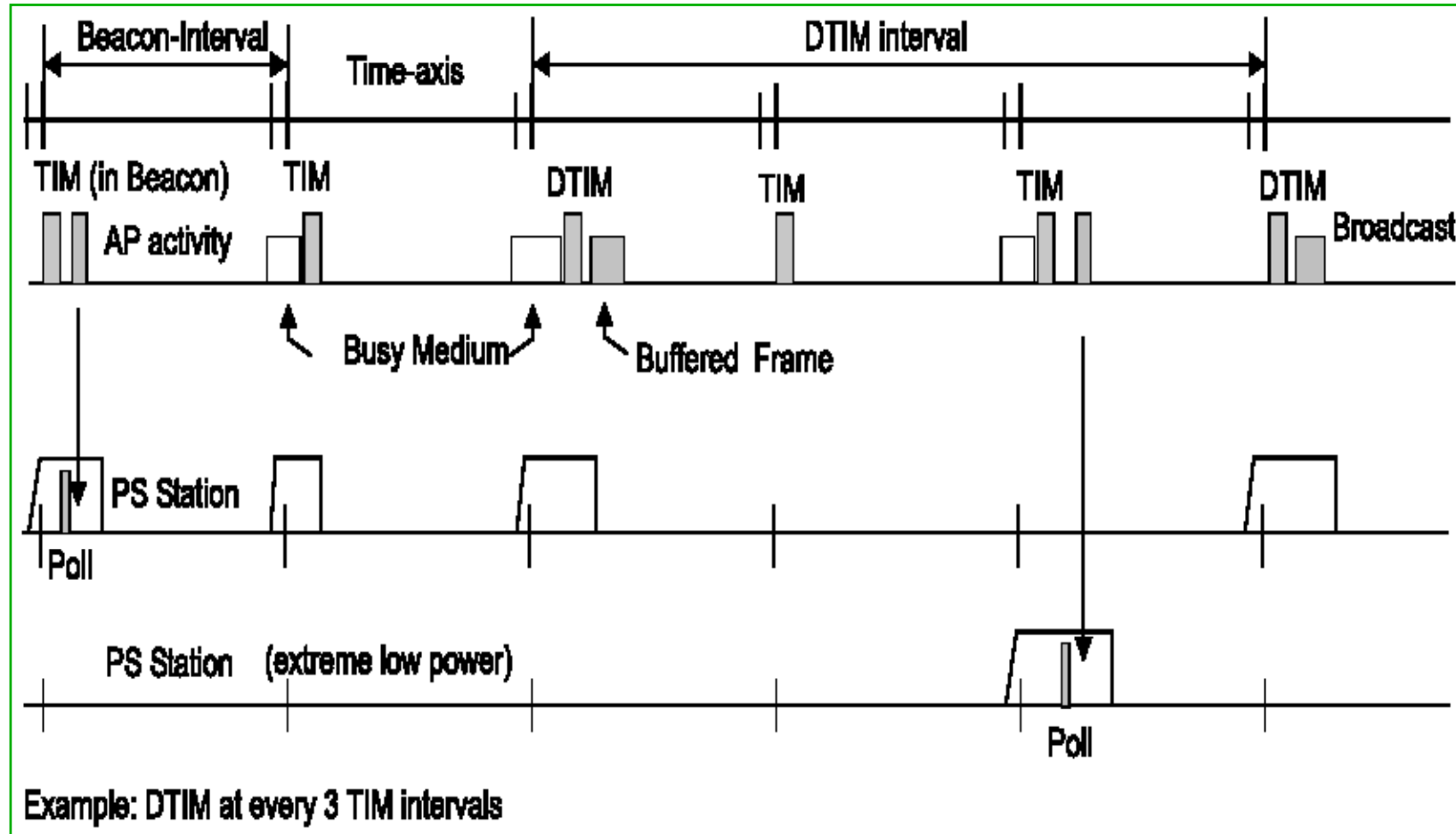

AP aging function

- ◆ **The AP shall have an aging function to delete buffered traffic when it has been buffered for an excessive period of time.**
- ◆ **The AP aging function shall not cause the buffered traffic to be discarded after any period that is shorter than the ListenInterval of the STA for which the traffic is buffered.**
- ◆ **The exact specification of the aging function is beyond the scope of this standard.**

Power management in an IBSS

- ◆ **The MSDUs that are to be transmitted to a power-conserving STA are first announced during a period when all STAs are awake.**
- ◆ **The announcement is done via an ad hoc traffic indication message (ATIM).**
- ◆ **A STA in the PS mode shall listen for these announcements to determine if it needs to remain in the awake state.**

Power management in an IBSS—Basic operation

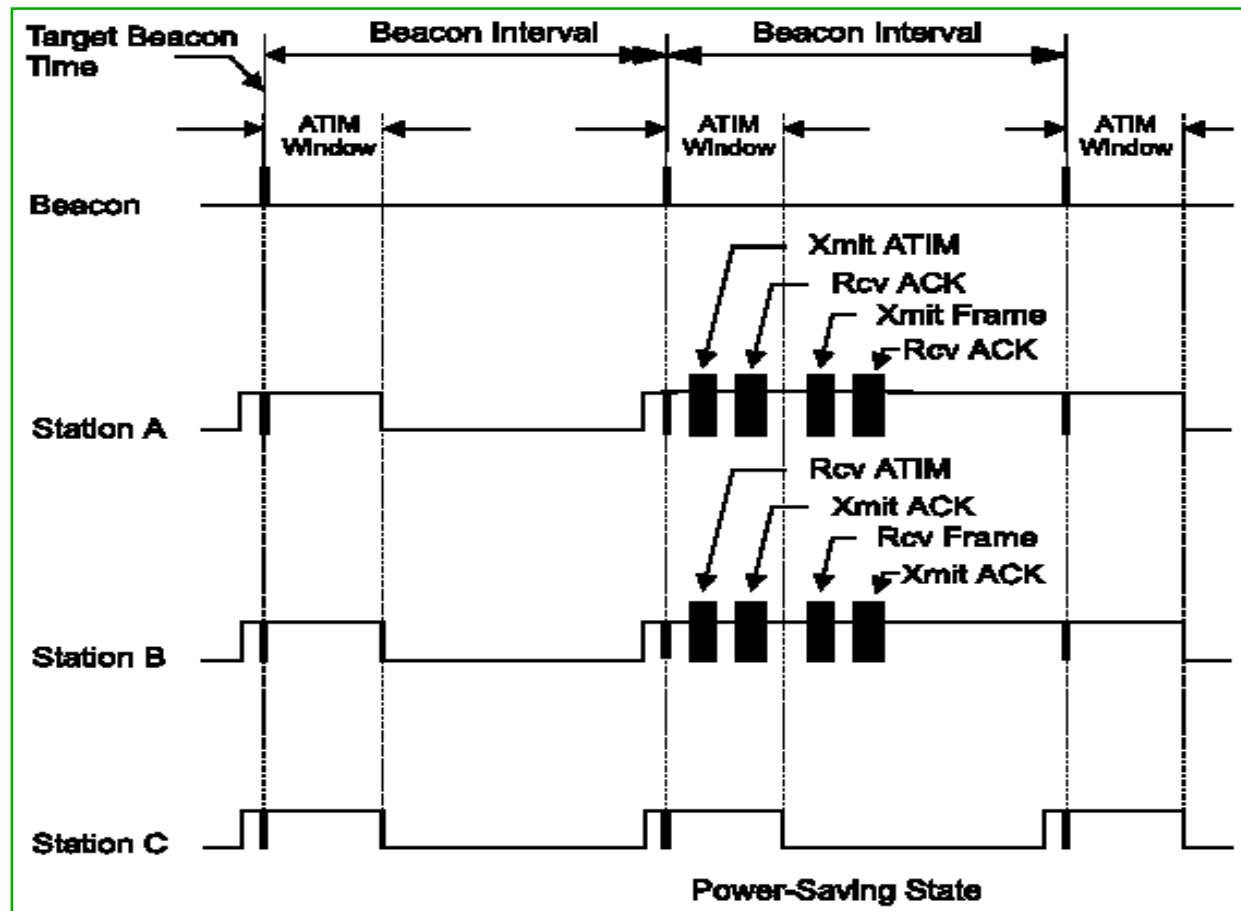

Initialization of power management within an IBSS

- ◆ **A STA joining an existing IBSS shall update its ATIM Window with the value contained in the ATIM Window field of the IBSS Parameter Set element within the Beacon or Probe Response management frame received during the scan procedure.**
- ◆ **A STA creating a new IBSS shall set the value of the ATIM Window field of the IBSS Parameter Set element within the Beacon management frames transmitted to the value of its ATIM Window.**

Cont.

- ◆ **The start of the ATIM Window shall be the TBTT, defined in 11.1.2.2. The end of the ATIM Window shall be defined as $\text{TSF timer MOD BeaconInterval} = \text{ATIMWindow}$.**
- ◆ **The ATIM Window period shall be static during the lifetime of the IBSS.**
- ◆ **An ATIM Window value of zero shall indicate that power management is not in use within the IBSS.**

STA power state transitions

- ◆ **If a STA is operating in PS mode, it shall enter the Awake state prior to each TBTT.**
- ◆ **If a STA receives a directed ATIM management frame containing its individual address, or a multicast ATIM management frame during the ATIM Window it shall remain in the Awake state until the end of the next ATIM Window.**

Cont.

- ◆ **If a STA transmits a Beacon or an ATIM management frame, it shall remain in the Awake state until the end of the next ATIM Window regardless of whether an acknowledgment is received for the ATIM.**
- ◆ **If the STA has not transmitted an ATIM and does not receive either a directed ATIM management frame containing its individual address, or a multicast ATIM management frame during the ATIM Window, it may return to the Doze state following the end of the current ATIM Window.**

Problem statement – multi-hop

- ◆ Clock synchronization
- ◆ Neighbor discovery
- ◆ Network partitioning

IEEE 802.11 PHY standard

Standard	Date issued	Available bandwidth (MHz)	Unlicensed frequency of operation (MHz)	No. of nonoverlapping channels *	Data rate per channel (Mbps)
802.11	1997	83.5	2.4 to 2.4835 DSSS, FHSS	3 indoor or outdoor	1, 2
802.11a	1999	300	5.15 to 5.35 OFDM (orthogonal frequency division multiplexing) 5.725 to 5.825 OFDM	4 indoor 4 indoor or outdoor 4 outdoor	6, 9, 12, 18, 24, 36, 48, and 54
802.11b	1999	83.5	2.4 to 2.4835 DSSS	3 indoor or outdoor	1, 2, 5.5, and 11
802.11g	2003	83.5	2.4 to 2.4835 DSSS, OFDM	3 indoor or outdoor	1, 2, 5.5, 6, 9, 11, 12, 18, 24, 36, 48, and 54

IEEE 802.11 DCF

- ◆ **Distributed Coordinated Function (DCF) defines a media access mechanism (CSMA/CA with binary exponential backoff and optional RTS/CTS mechanism).**

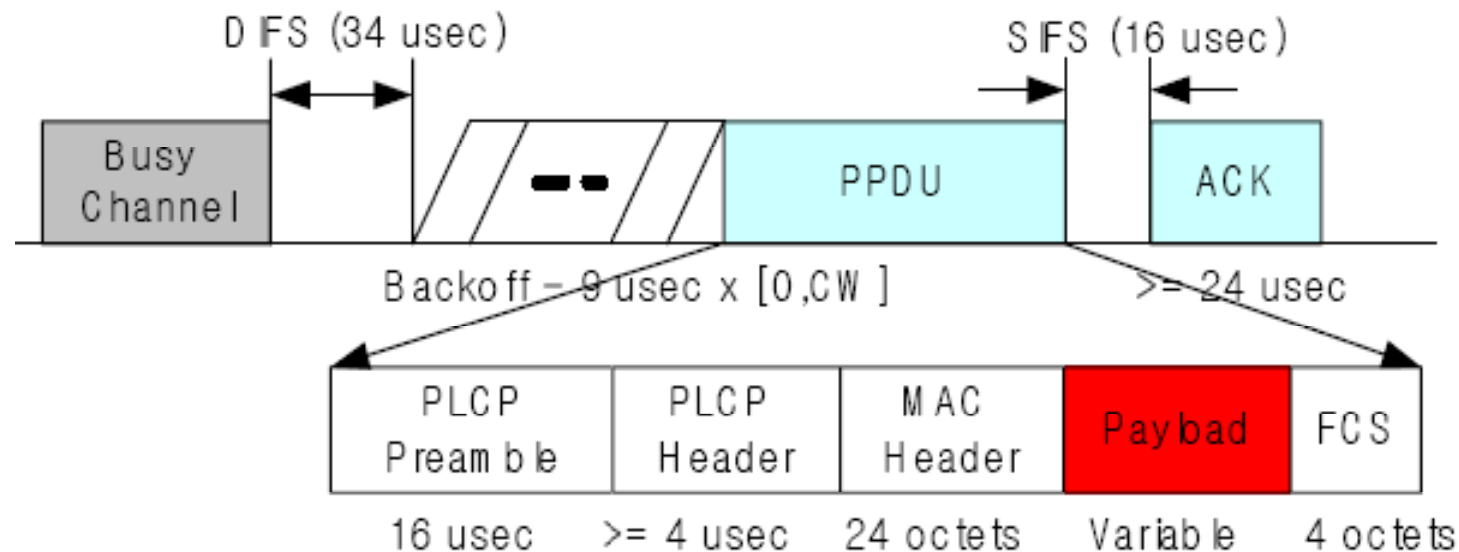

Notations

T_{slot}	A slot time.
T_{SIFS}	SIFS time.
T_{DIFS}	DIFS time.
CW_{min}	Minimum backoff window size
T_p	Transmission time of the physical preamble.
T_{PHY}	Transmission time of the PHY header.
$L_{\text{H_DATA}}$	MAC overhead in bytes, i.e., 28 bytes.
L_{ACK}	ACK size in bytes, i.e., 14 bytes.
$T_{\text{H_DATA}}$	Transmission time of MAC overhead.
L_{DATA}	Payload size in bytes.
T_{DATA}	Transmission time for the payload.
T_{SYM}	Transmission time for a symbol.
t	Propagation delay.
R_{DATA}	Data rate.
R_{ACK}	Control rate.

Parameter of IEEE 802.11a & 802.11b

Parameter	802.11a	802.11b	Parameter	802.11a	802.11b
T_{slot}	$9\mu s$	$20\mu s$	T_{SIFS}	$16\mu s$	$10\mu s$
τ	$1\mu s$	$1\mu s$	CW_{min}	15	31
T_p	$16\mu s$	$144\mu s$	T_{PHY}	$4\mu s$	$48\mu s$
T_{DIFS}	$34\mu s$	$50\mu s$	T_{SYM}	$4\mu s$	N/A

Assumption

- ◆ **The System must be at the best-case scenario:**
 - Error-free channel
 - At any transmission cycle, only one active station which always has a packet to send and other stations can only accept packets and provide ACK.

Throughput upper limit (TUL) & Delay lower limit (DLL)

$$\overline{CW} = \frac{(CW_{\min} - 1)T_{\text{slot}}}{2} \dots\dots\dots(1)$$

$$T_{D_DATA} = T_P + T_{\text{PHY}} + T_{H_DATA} + T_{\text{DATA}} \dots\dots\dots(2)$$

$$T_{D_ACK} = T_P + T_{\text{PHY}} + T_{\text{ACK}} \dots\dots\dots(3)$$

$$MT = \frac{8L_{\text{DATA}}}{T_{D_DATA} + T_{D_ACK} + 2t + T_{\text{DIFS}} + T_{\text{SIFS}} + \overline{CW}} \dots\dots\dots(4)$$

$$MD = T_{D_DATA} + t + T_{\text{DIFS}} + \overline{CW} \dots\dots\dots(5)$$

IEEE 802.11b DATA & ACK transmission time

$$T_{D_DATA} = T_P + T_{PHY} + \frac{8L_{H_DATA} + 8L_{DATA}}{100000R_{DATA}} \dots\dots\dots(6)$$

$$T_{D_ACK} = T_P + T_{PHY} + \frac{8L_{ACK}}{100000R_{ACK}} \dots\dots\dots(7)$$

PPDU frame format of IEEE 802.11a

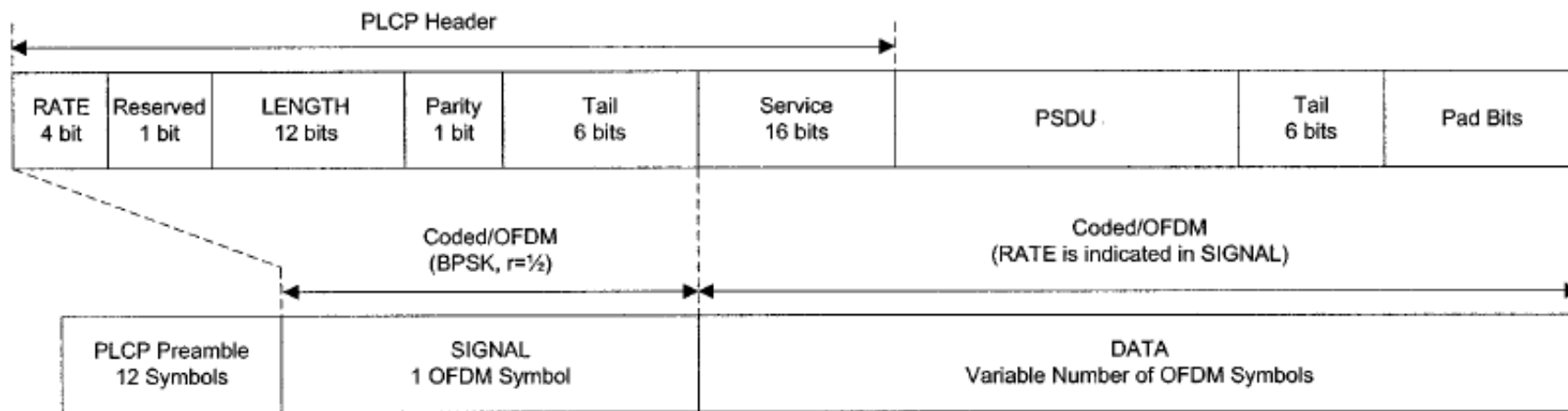

IEEE 802.11a DATA & ACK transmission time

$$T_{D_DATA} = T_P + T_{PHY} + T_{SYM} * \text{Ceiling}\left(\frac{16 + 6 + 8L_{H_DATA} + 8L_{DATA}}{N_{DBPS}}\right) \dots (8)$$

$$T_{D_ACK} = T_P + T_{PHY} + T_{SYM} * \text{Ceiling}\left(\frac{16 + 6 + 8L_{ACK}}{N_{DBPS}}\right) \dots (9)$$

TUL and DLL

$$TUL = \frac{8L_{DATA}}{2T_P + 2T_{PHY} + 2t + T_{DIFS} + T_{SIFS} + \frac{(CW_{min} - 1)T_{slot}}{2}} \dots(10)$$

$$DLL = T_P + T_{PHY} + t + T_{DIFS} + \frac{(CW_{min} - 1)T_{slot}}{2} \dots\dots\dots(11)$$

Maximum throughputs and TUL (Mbps) of 802.11a

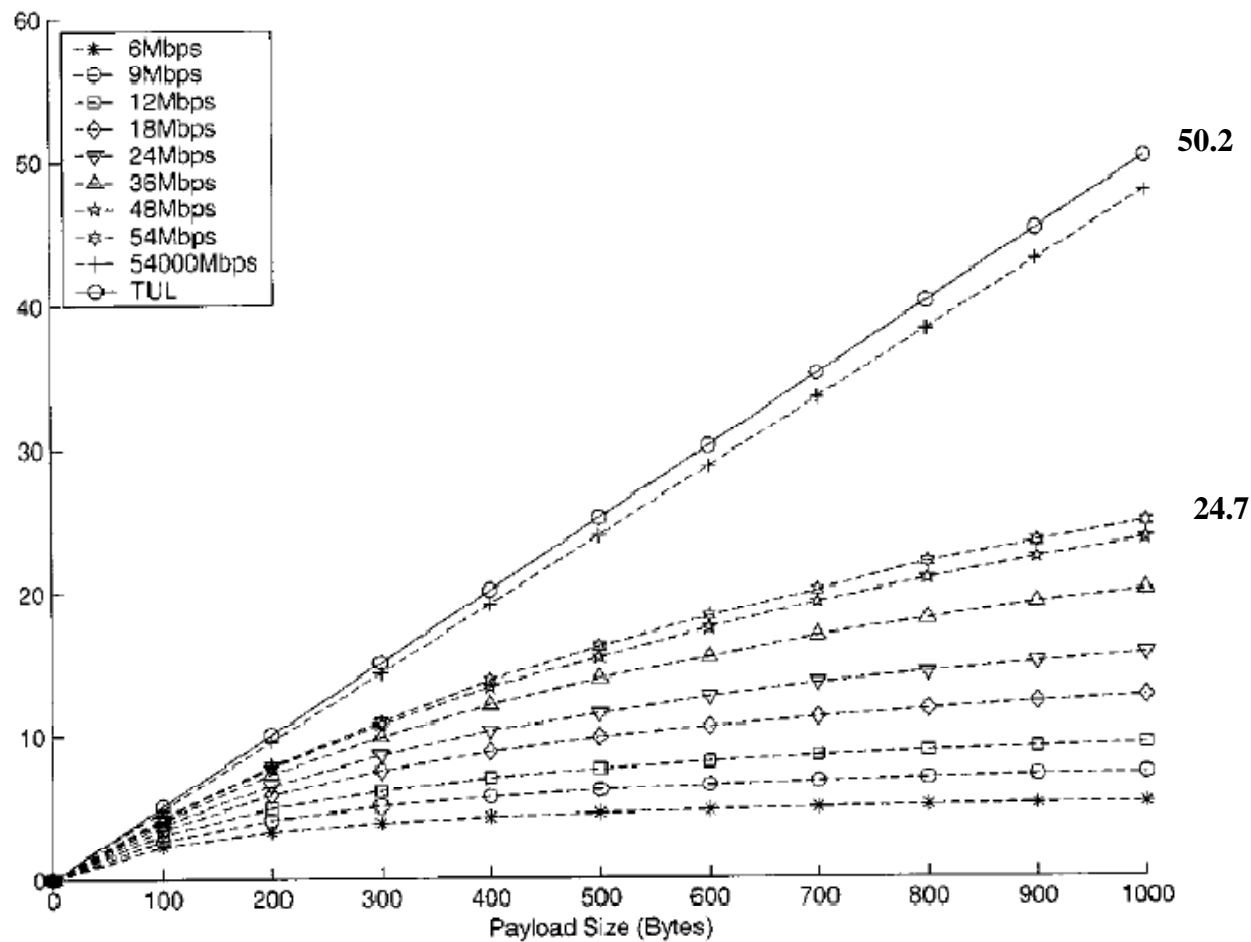

Minimum delays and DLL (seconds) of 802.11a

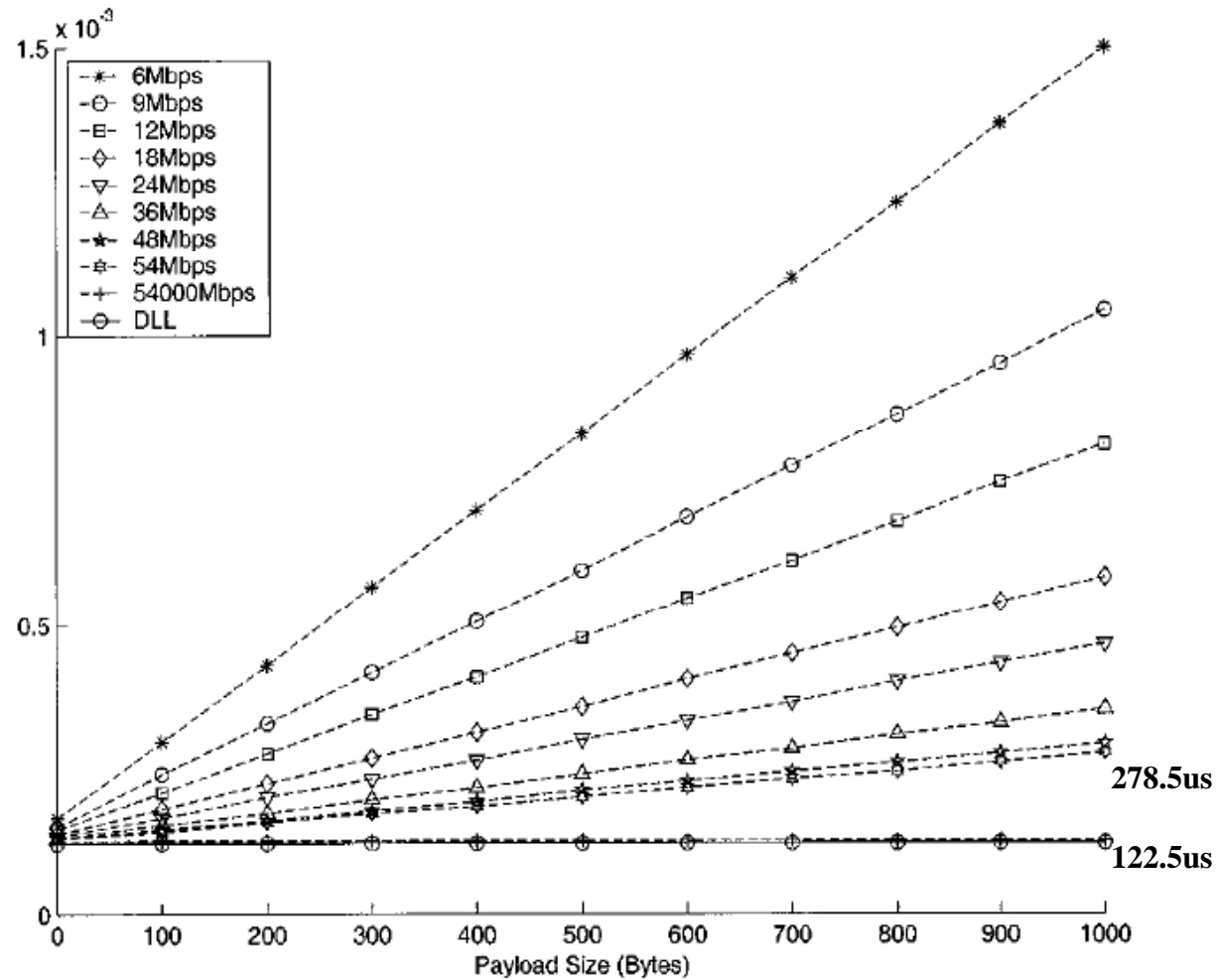

Maximum throughputs and TUL (Mbps) of 802.11b

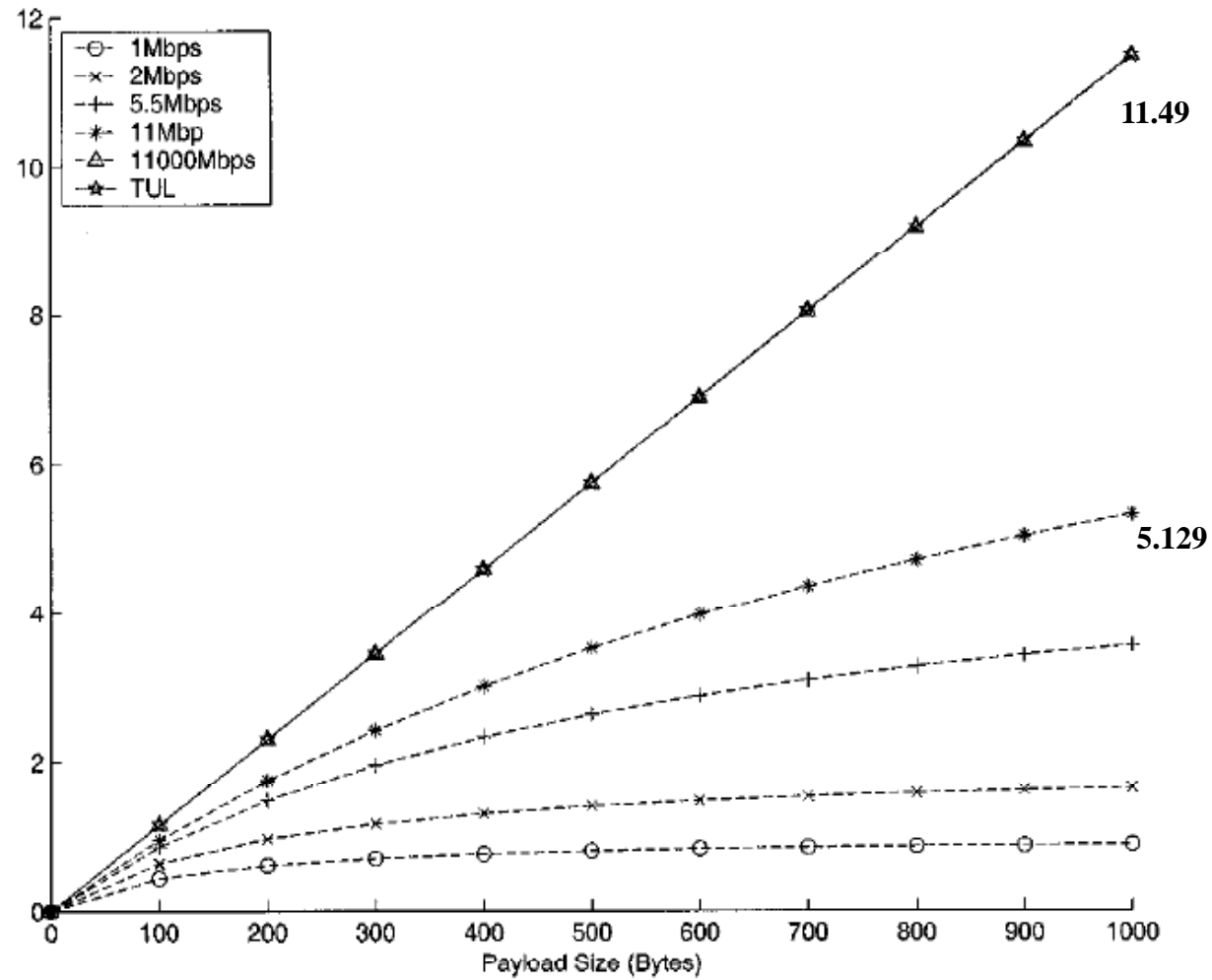

Minimum delays and DLL (seconds) of 802.11b

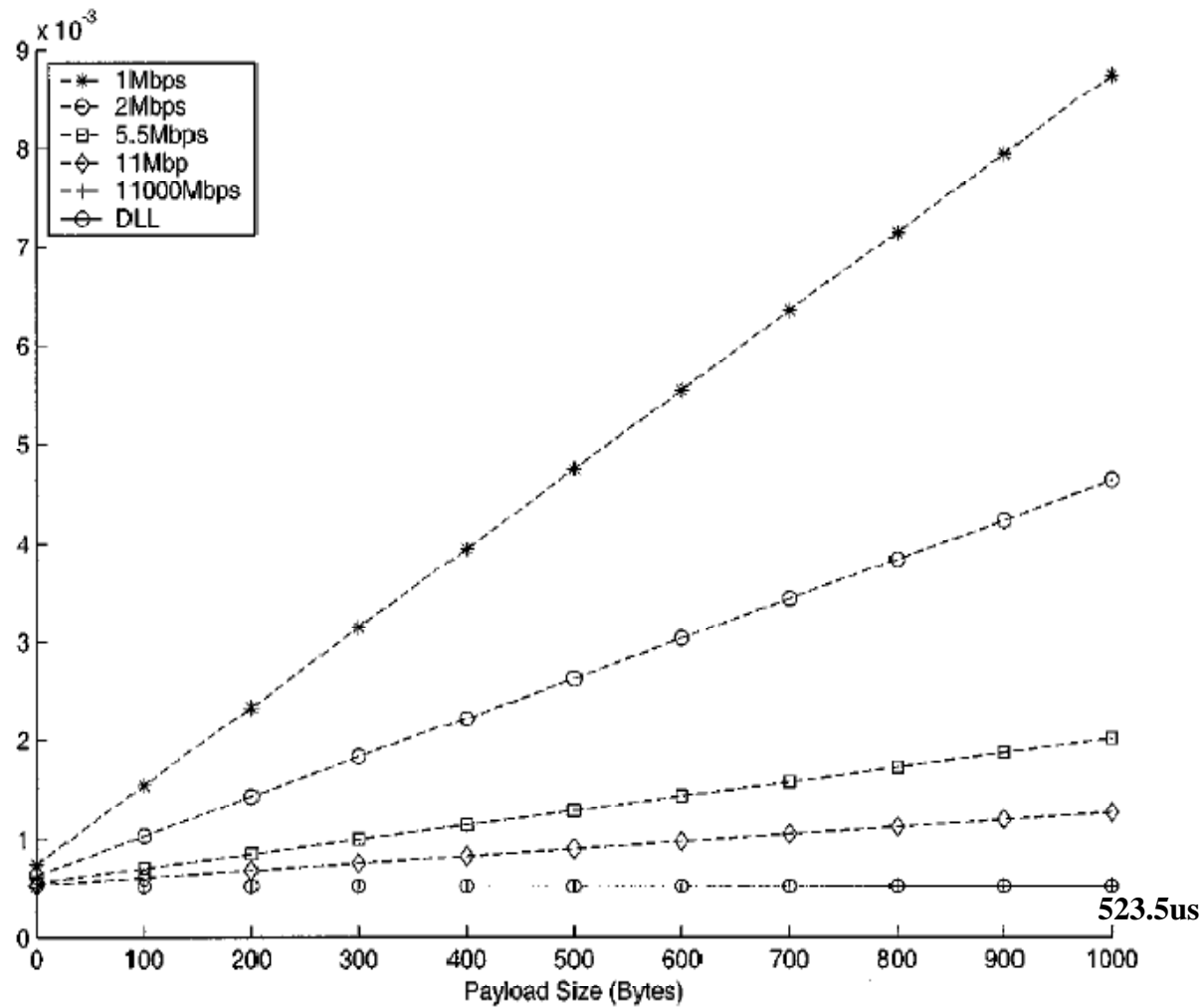

PHY Frame Aggregation

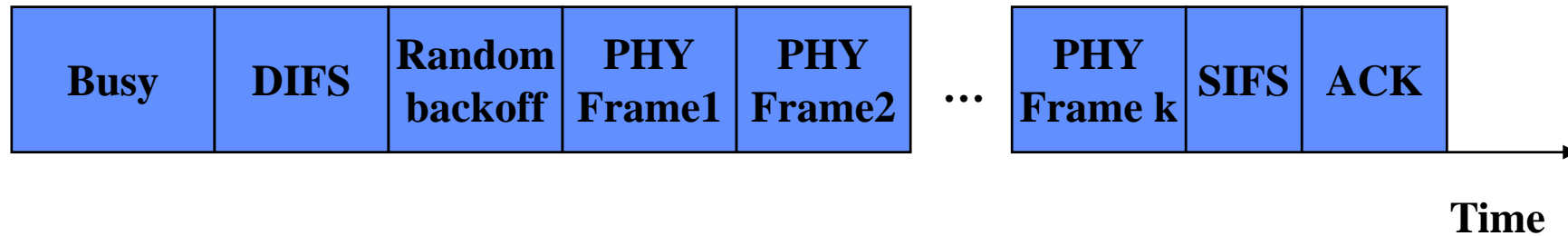

$$MT = \frac{8k * L_{DATA}}{kT_{DATA} + T_{ACK} + 2t + T_{DIFS} + T_{SIFS} + \frac{(CW_{min} - 1)T_{slot}}{2}} \dots\dots\dots(10)$$

$$TUL = \frac{8k * L_{DATA}}{(k+1)(T_P + T_{PHY}) + 2t + T_{DIFS} + T_{SIFS} + \frac{(CW_{min} - 1)T_{slot}}{2}} \dots(11)$$

Comparison of MT and TUL

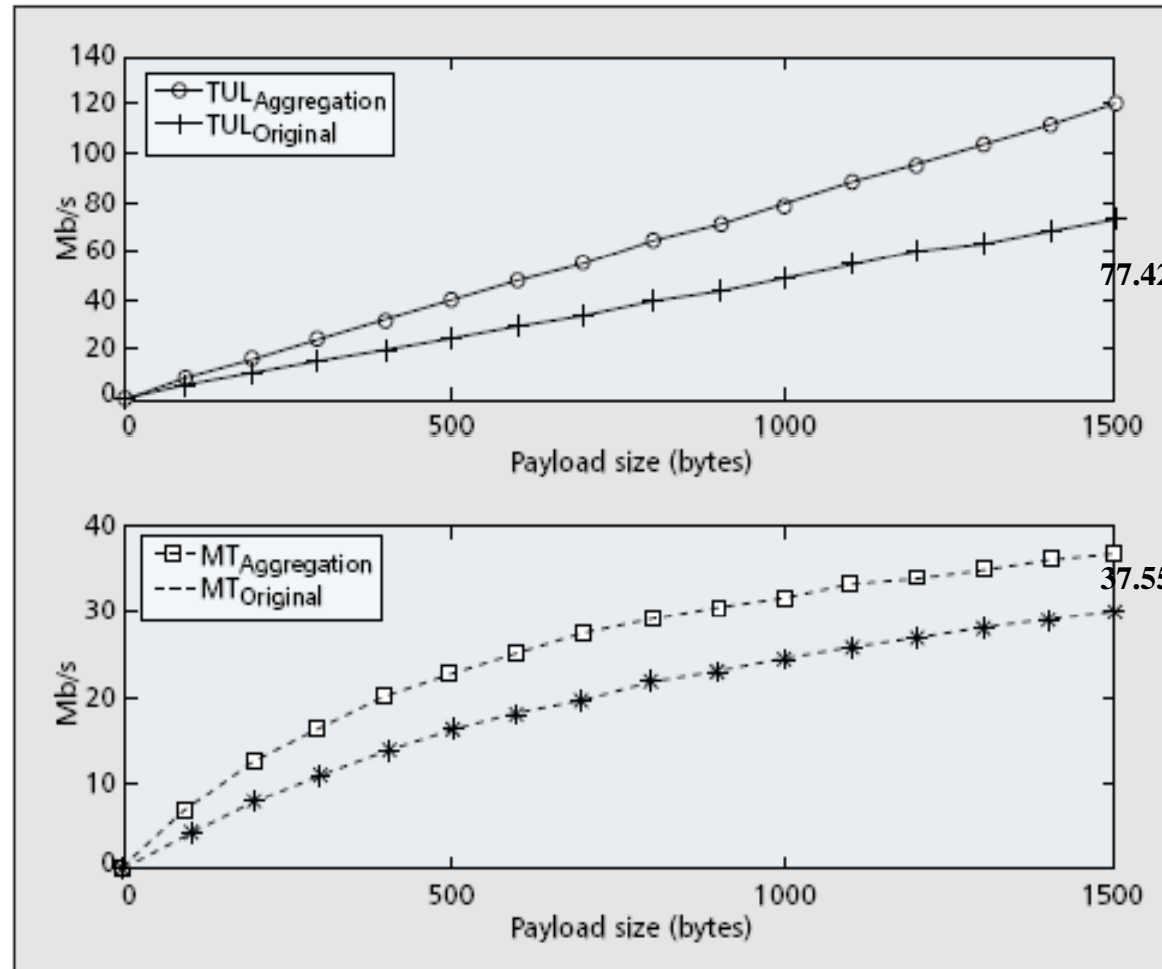

54Mbps, k=2

HIPERLAN/2 MAC frame

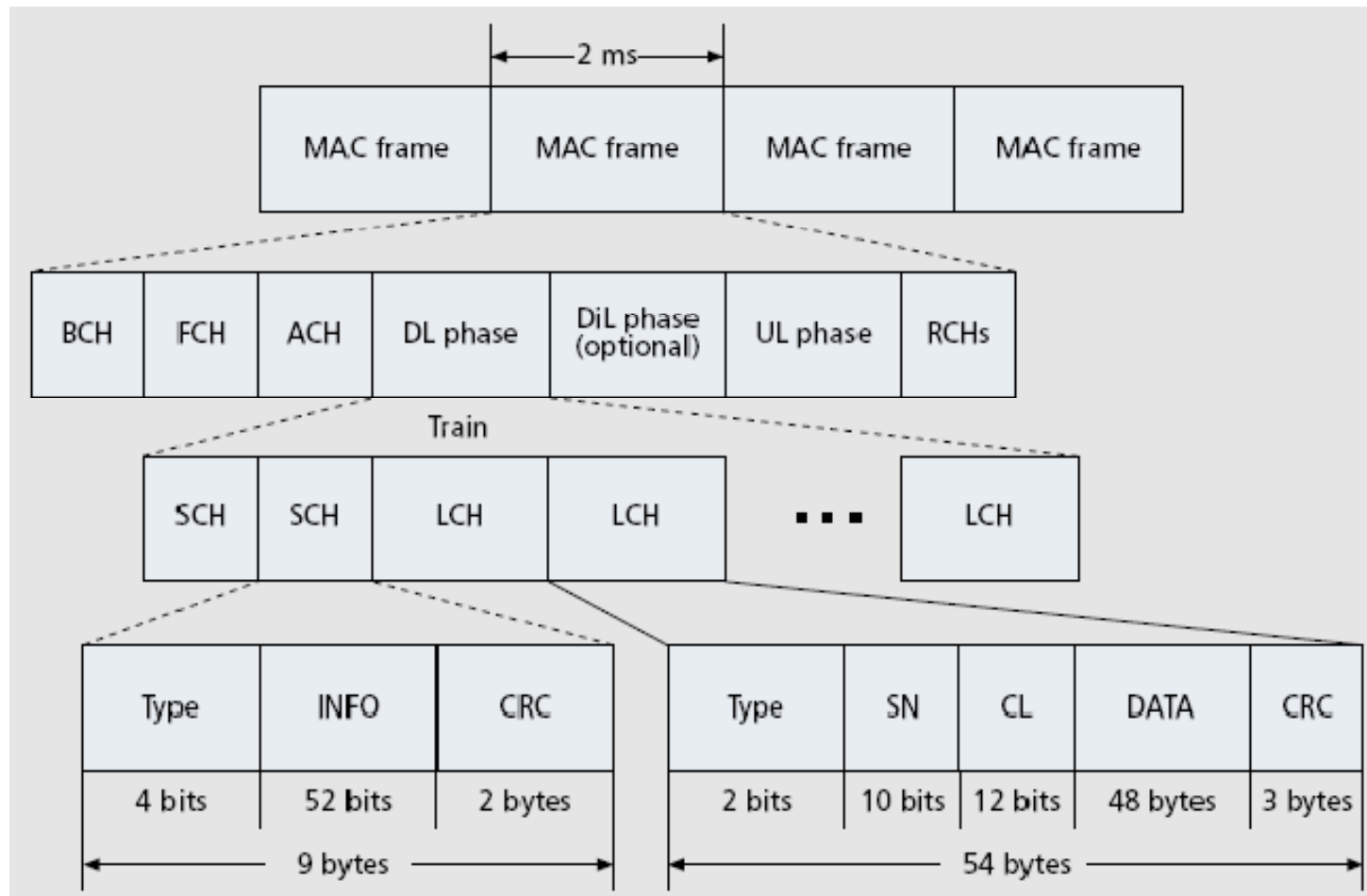

Throughput HIPERLAN/2

$$MT = \frac{8L_{DATA}}{\cancel{T_{D_DATA}} + \cancel{T_{D_ACK}} + t + \cancel{T_{DIFS}} + \cancel{T_{SIFS}} + \cancel{CW}}$$

Obersvations

- ◆ **The existence of the TUL and DLL shows that by simply increasing the data rate without reducing overhead, the enhanced throughput is bounded even when the data rate goes to infinite high.**
- ◆ **Reducing overhead is necessary for IEEE 802.11 standards to achieve higher throughput.**