

無線網路多媒體系統

Wireless Multimedia System

Lecture 10: Multicast support for Mobile Hosts

Dr. Eric Hsiaokuang Wu

We
provide
無線網路多媒體實驗室
Wireless
Wireless Network & Multimedia Laboratory
Solution

Basic Motivations

- ◆ Mobile Network

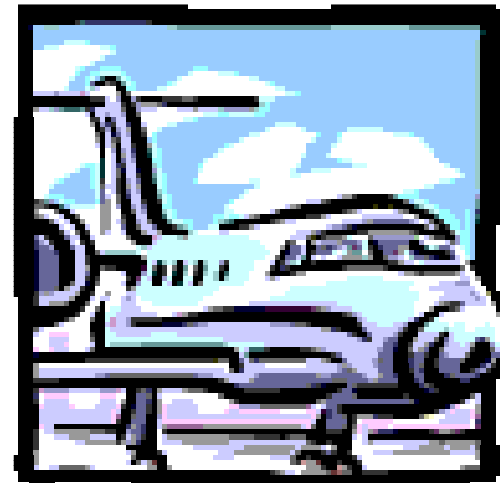

New Requirements

One to Many Mobile Multicasting Services

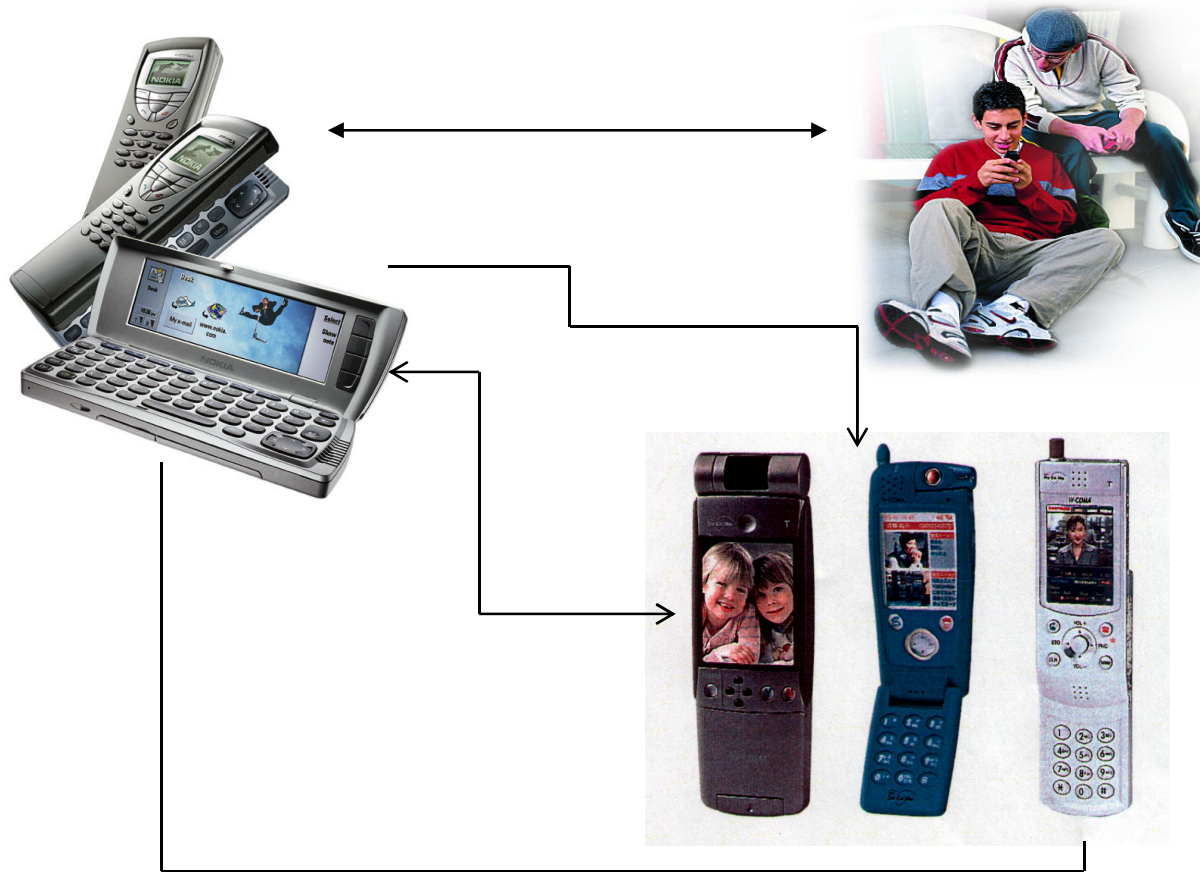

Reading

- ◆ [Chikamane1998] V. Chikamane, C. L. Williamson, R. B. Bunt, W. L. Mackrell, “Multicast support for mobile hosts using Mobile IP: Design issues and proposed architecture, Mobile Networks and applications (1998)
- ◆ [Williamson1998] C.L. Williamson, T.G. Harrison, W.L. Mackrell and R. B. Bunt, “Performance evaluation of the MoM mobile multicast protocol, Mobile Networks and Applications, (1998)
- ◆ [Imed2004] IMED ROMDHANI, MOUNIR KELLIL, AND HONG-YON LACH, “IP Mobile Multicast: Challenges and Solutions”, IEEE Communications Survey 2004.

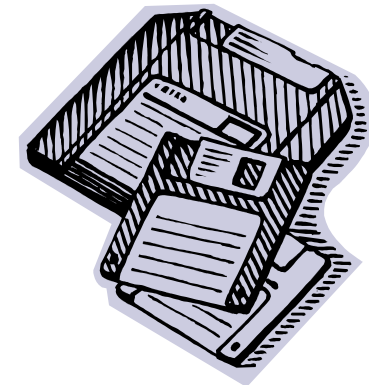

IP Multicast Applications

One-to-Many

- Database Updates
- Live Concerts
- Broadcasts
- News Feeds
- Push Media
- Caching
- Announcements
- Monitoring
- Etc.

Many-to-Many

- Multimedia Conferencing
- Synchronized Resources
- Concurrent Processing
- Collaboration
- Distance Learning
- Chat Groups
- Distributed Simulations
- Interactive Music Sessions
- Etc.

IP Multicast

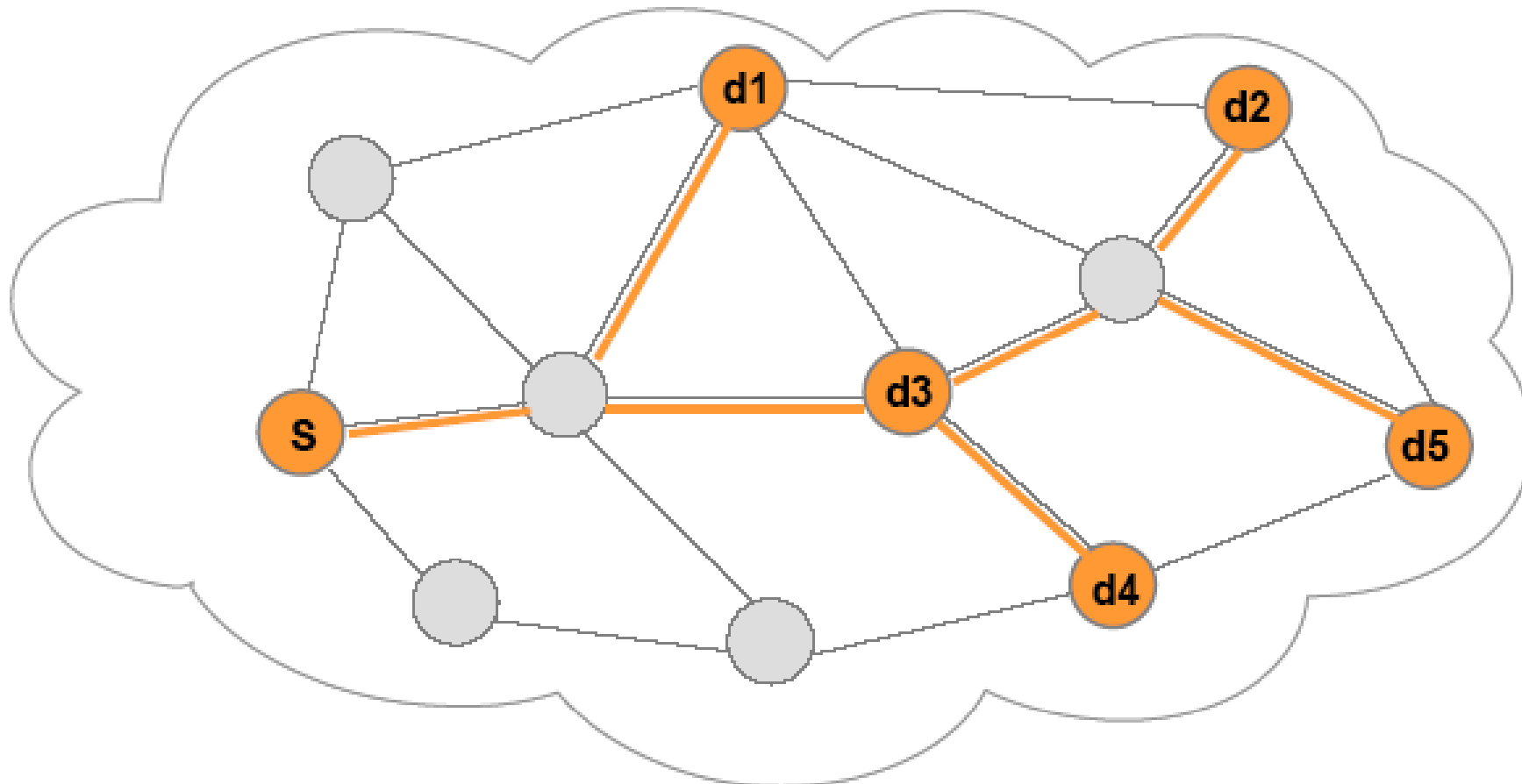

IP Multicast Applications

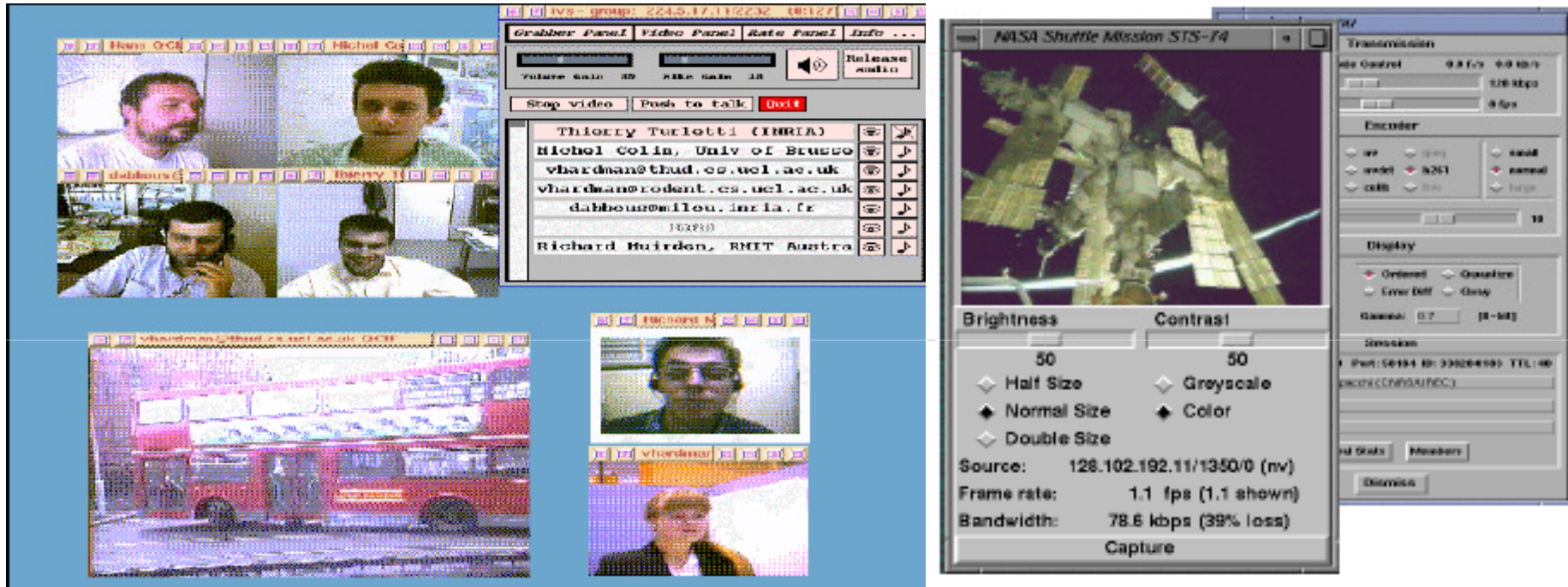

Agenda

- ◆ Fundamental Approaches:

- Multicast Support for Mobile Host using Mobile IP

- ◆ Advanced Approaches:

- Mobile Multicast Protocol (MoM)
 - Multicast by Multicast Agent (MMA)
 - Mobile Network Gateway (MNG)
 - Synchronization



Fundamental Approach: IP Multicast for Mobile Hosts



Mobile IP Approach

Challenges and Solutions

- ◆ Providing multicast in an inter-network with mobile hosts is made difficult
 - Many multicast protocols are inefficient when faced with *frequent membership* or *location changes*
- ◆ Proposing an architecture to support IP multicast for mobile hosts using Mobile IP
 - The *tunnel convergence problem*, the *duplication problem*, and the *scoping problem*



Terminology of IP Mobility

- ◆ Home address
 - An IP address that is assigned for an extended period of time to a mobile node. It remains unchanged regardless of where the node is attached to the Internet.
- ◆ Care-of Address
 - The termination point of a tunnel toward a mobile node, for datagrams forwarded to the mobile node while it is away from home
 - ◆ Foreign agent care-of address
 - ◆ Co-located care-of address

Triangle routing of Mobile IP

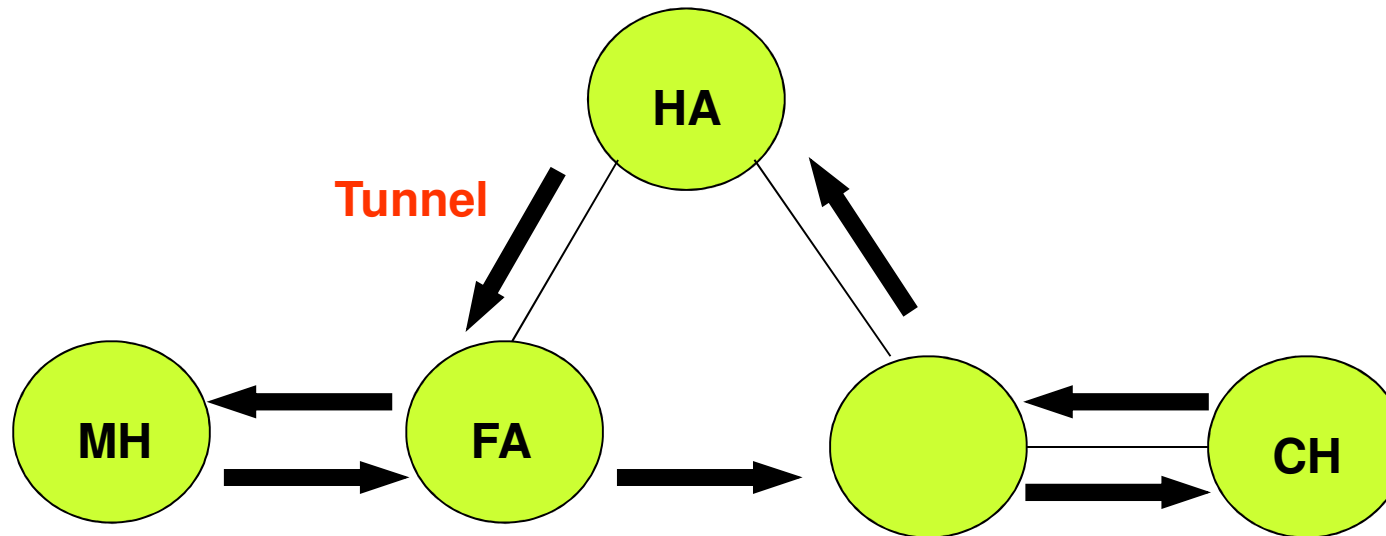

- ◆ Datagrams from the MH are delivered directly to its correspondent host (CH), but datagrams from the CH to the MH must first go to the HA, which forwards them to the foreign agent (FA).

Mobile Multicast Issues

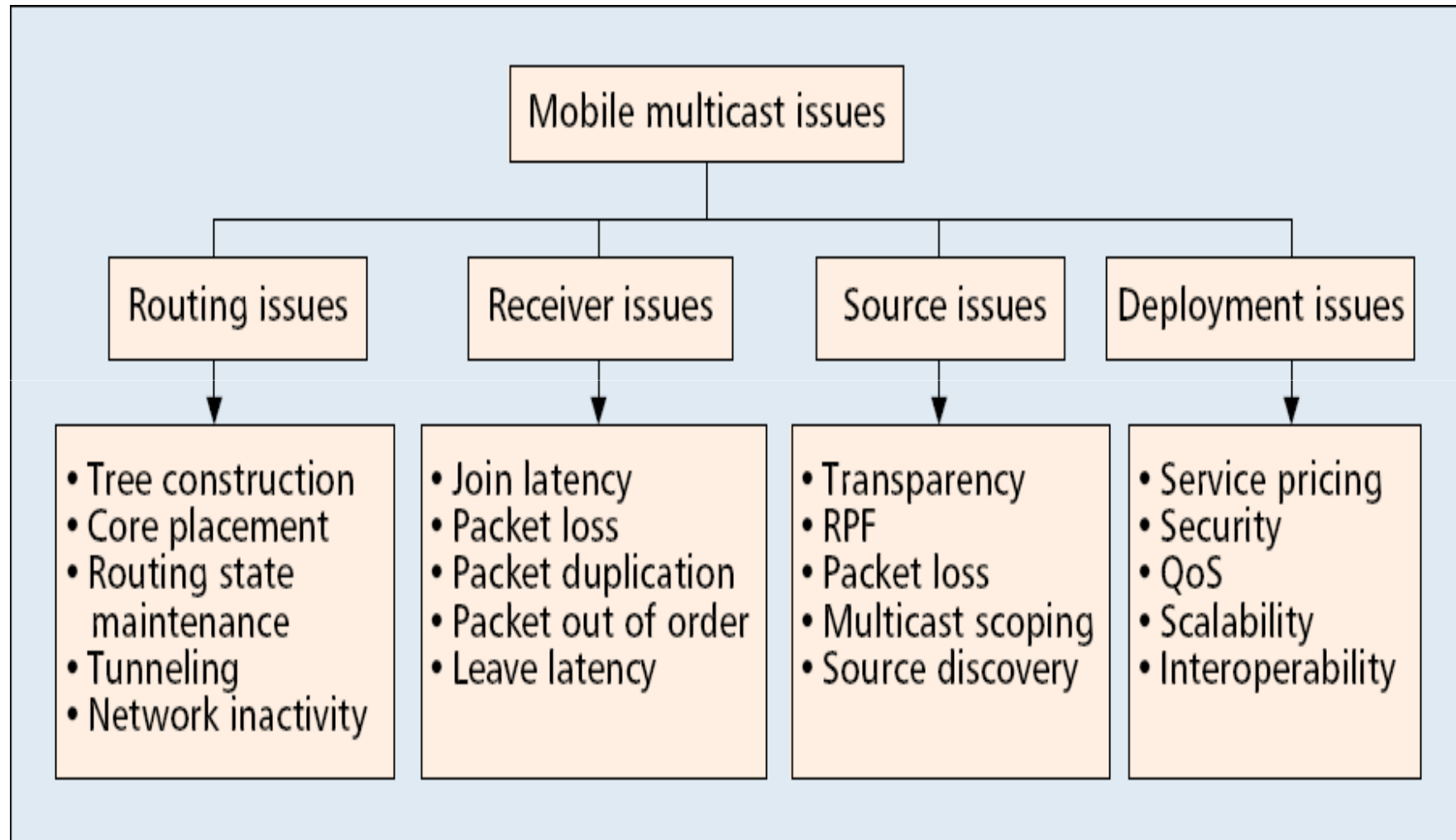

Current IETF Mobile IP multicast

- ◆ Remote subscription
 - The mobile host is required to re-subscribe to the multicast group on each foreign
 - Using a co-located care-of address
 - Advantage
 - ◆ Providing the most efficient delivery of multicast datagrams
 - Disadvantage
 - ◆ may come at a high price for the networks involved
 - ◆ the multicast routers that must manage the multicast tree

Current IETF Mobile IP multicast (cont.)

- ◆ Bi-directional tunneled multicast
 - The home agent must also be a multicast router
 - Subscriptions are done through the home agent
 - Disadvantage
 - ◆ If multiple mobile hosts on the same foreign network belong to the same multicast then duplicate copies of the multicast packets will arrive at the foreign network
 - ◆ Multiple encapsulation increases the packet size substantially and can cause fragmentation

Multicast Reception on Mobile Hosts

- ◆ Home Agent Routing
 - HA and MH communication via virtual PtP links
- ◆ Foreign Agent Routing
 - FA acting as an MR hides the MH addresses
 - Trade-off
- ◆ Combined Routing
 - The FA gathers membership information and arranges for unique or more tunnels to be set up for each group
 - MoM

Home Agent Routing

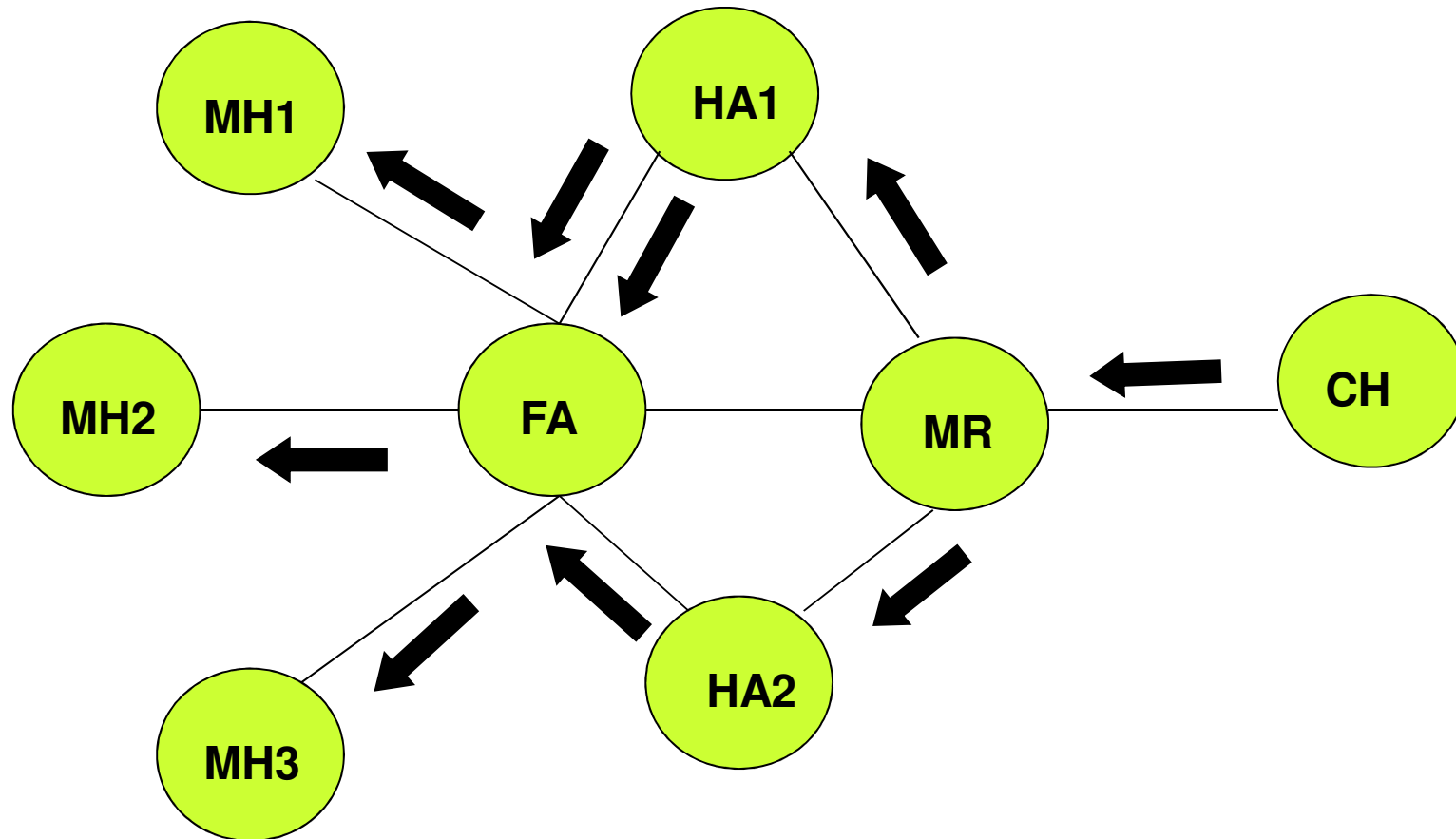

Mobile IP Home Subscribe Approach

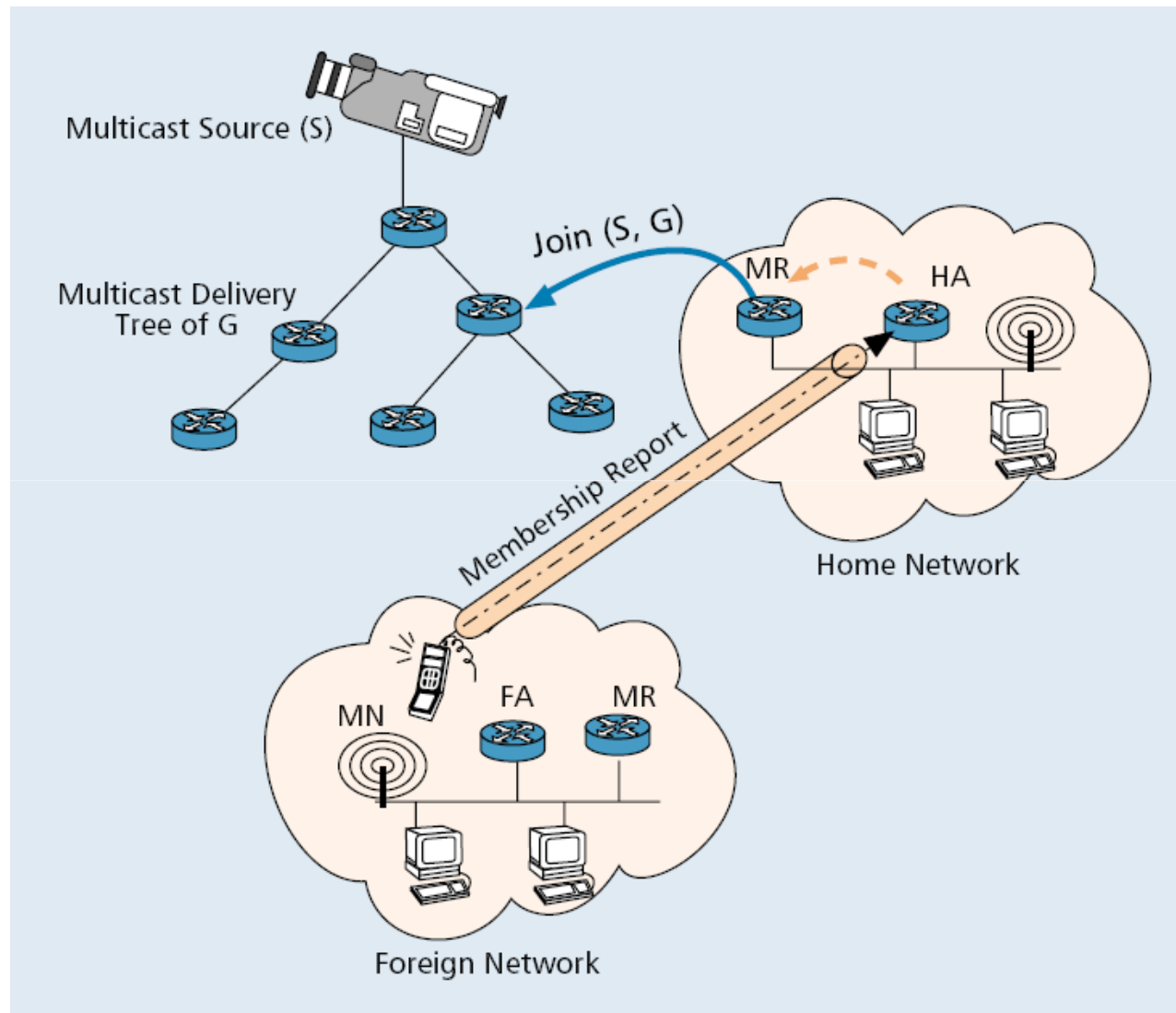

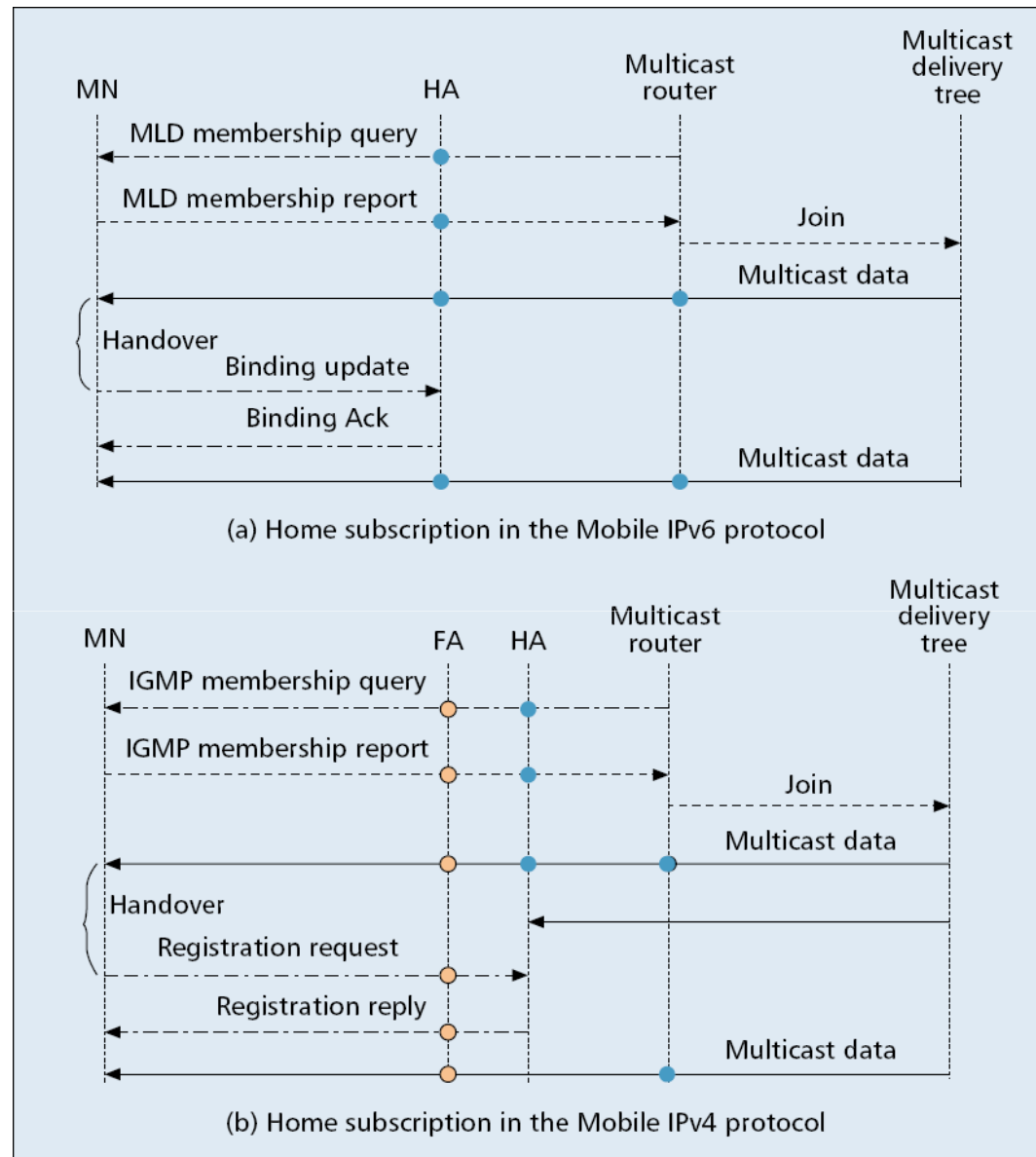

Foreign Agent Routing

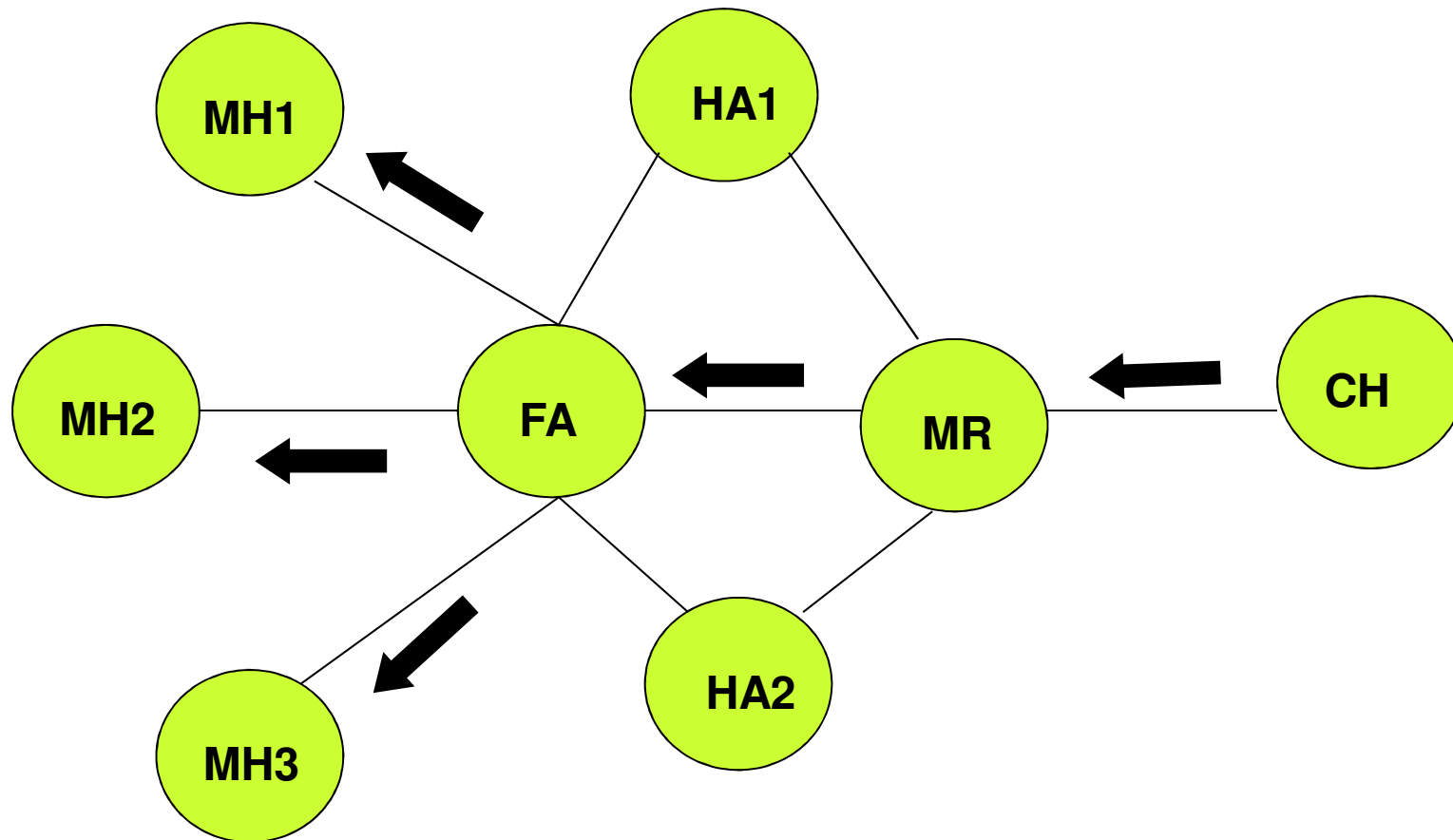

Remote Subscription Approach

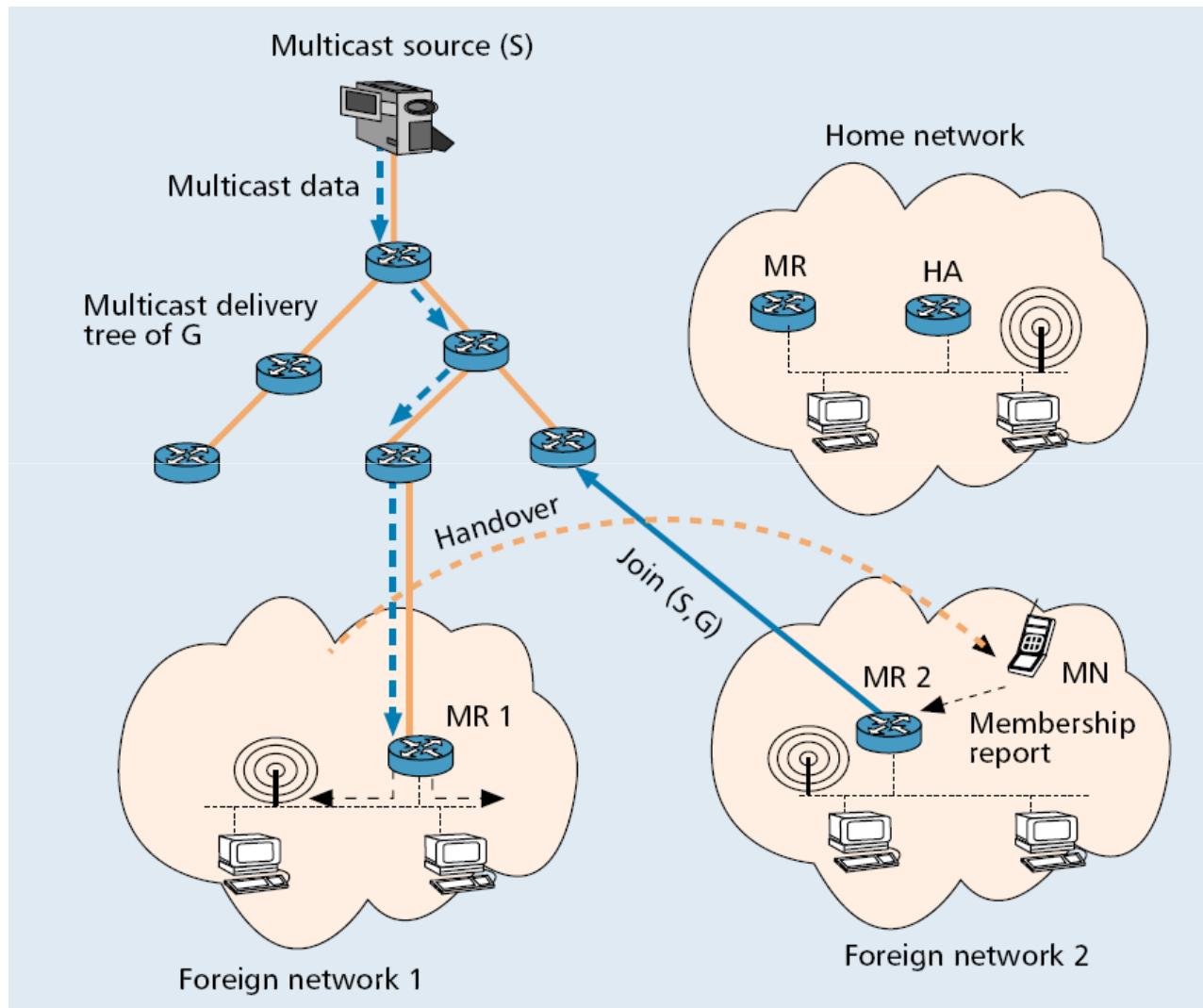

Combined Routing

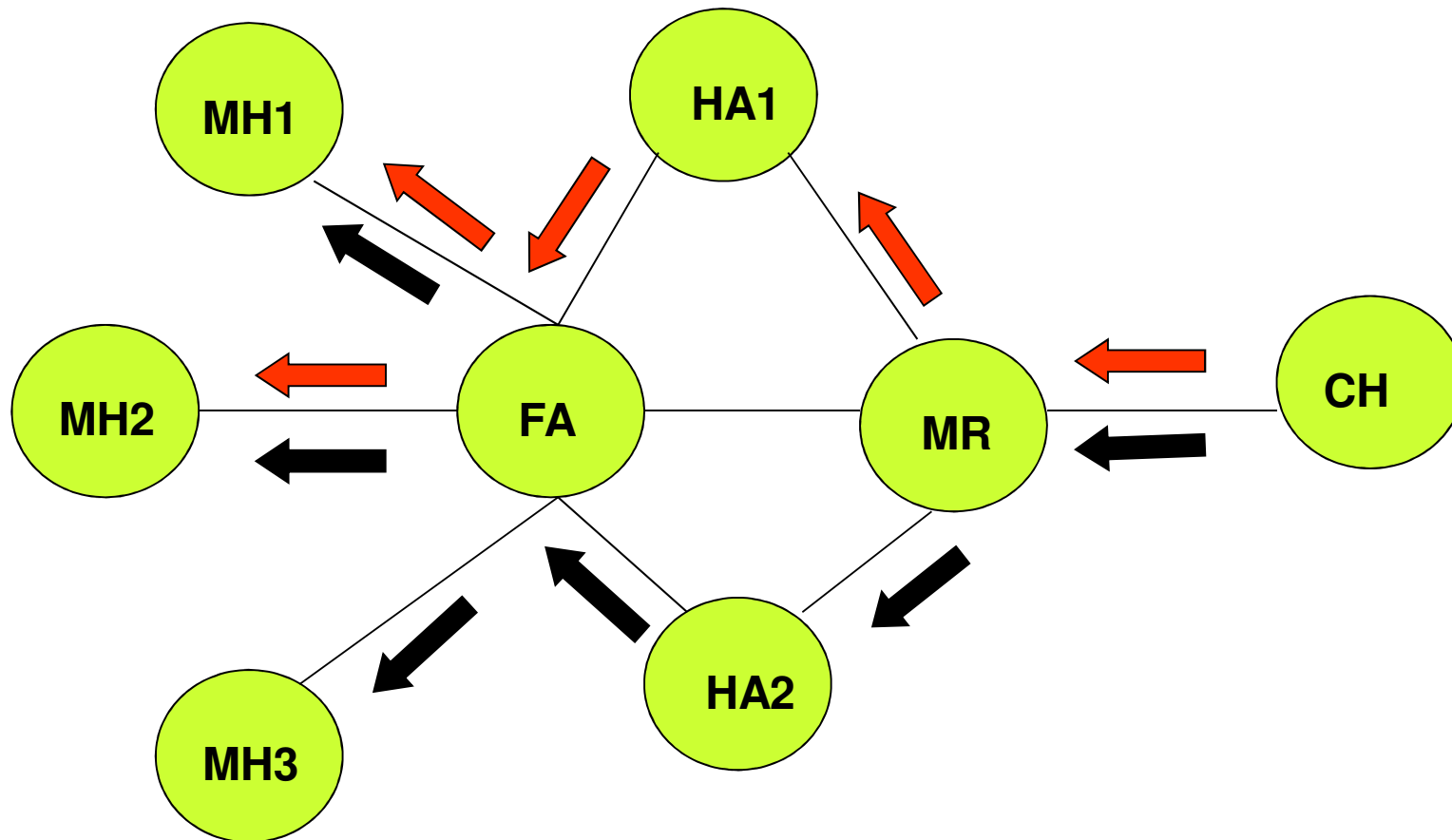

MH3 first reported group membership to the FA

MoM Approach

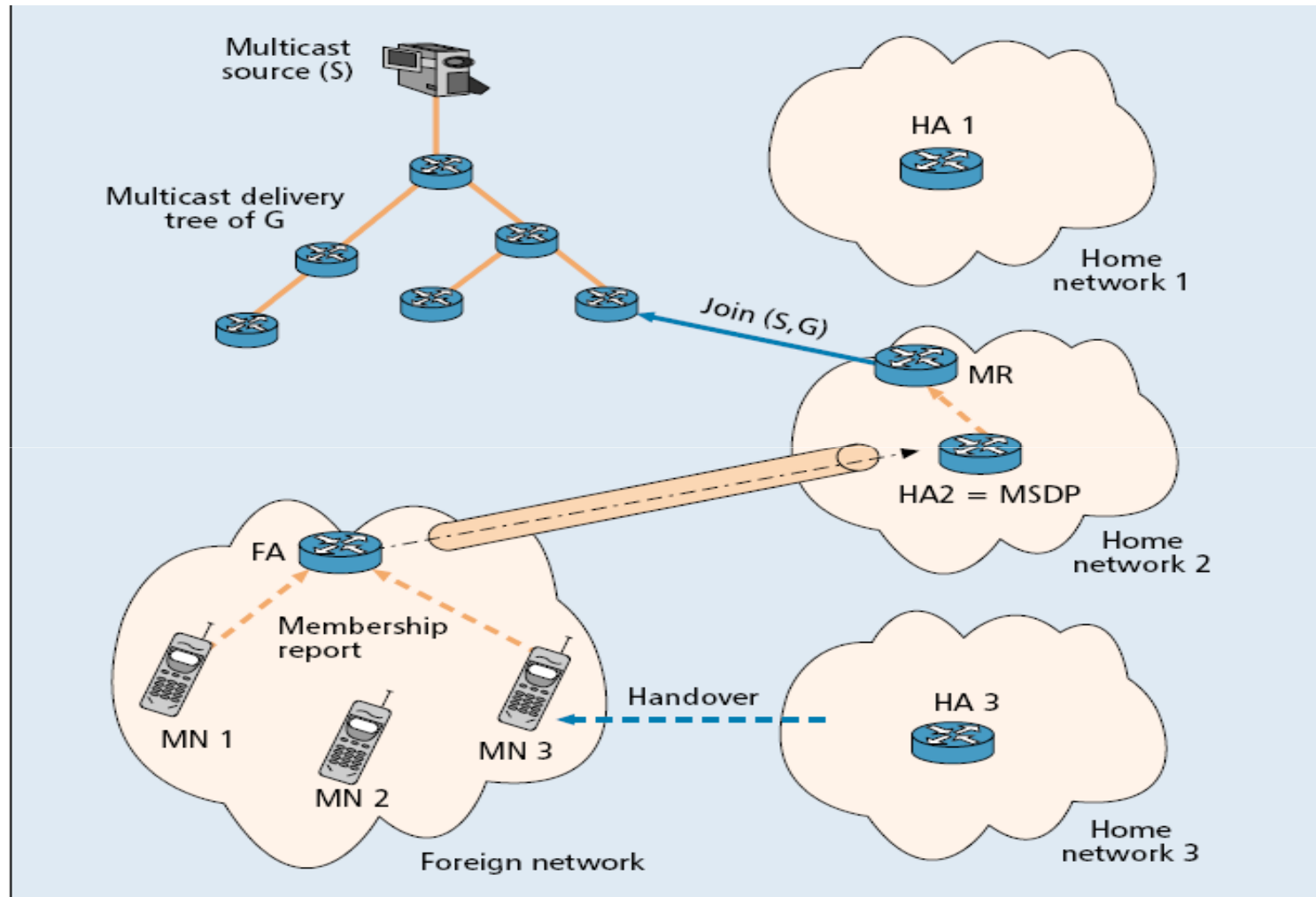

Assumptions of MoM

- ◆ The service to be provided is the unreliable, best effort, connectionless delivery of multicast datagrams
- ◆ Dynamic group membership is a necessary feature of multicast
- ◆ A mobile host that wishes to receive multicast datagrams is capable of receiving them on its home network using existing multicast routing techniques
- ◆ The home agent and foreign agent are static hosts
- ◆ There is exactly one foreign agent per network visited

Handling multicast source mobility

- ◆ On its home network
 - The mobile host uses link-level multicast to send the datagram
 - The home agent propagates the multicast downstream normally
- ◆ On a foreign network
 - The mobile host uses a tunnel to deliver the datagram to its home agent
 - The multicast home agent then propagates the multicast datagram downstream via all interface
- ◆ In both cases, the source address in the multicast packets is the mobile host's home address

Handling multicast destination mobility

- ◆ Home agent is one of many group members
- ◆ Foreign agent need not join groups on behalf of mobiles that visiting its network
- ◆ Home agent need not forward a separate copy for each mobile host that it serves, but only one copy for each foreign network at which its mobile host group member reside
 - MoM differs from the IETF bi-directional tunneling approach in which multicast packets are delivered as *unicast* packets to each mobile host

Advanced Approach (I)



MoM

Problems and Issues of MoM

- ◆ The tunnel convergence problem
- ◆ The duplication problem
- ◆ Disruptions of multicast service

The duplication problem

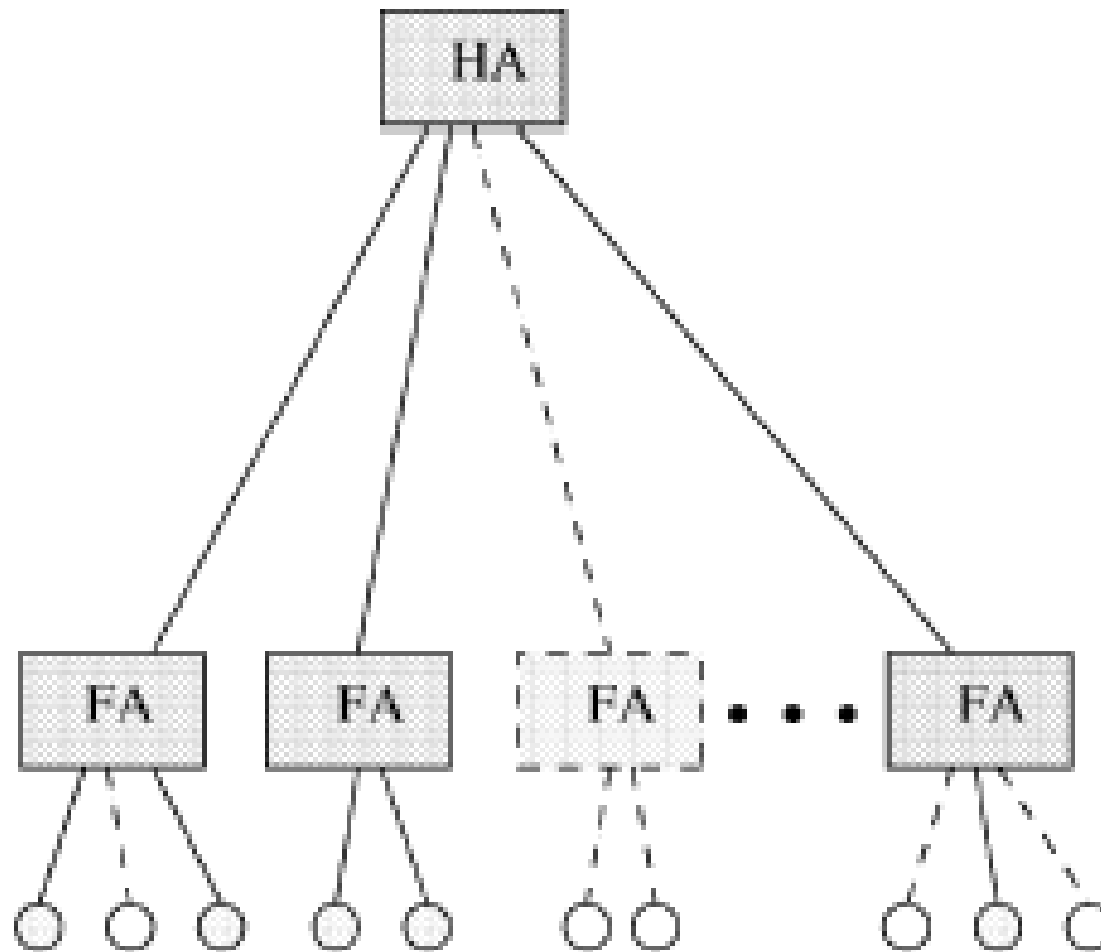

The duplication problem

- ◆ If bi-directional tunneling is used, all multicast packets are forwarded individually to each MH by its HA
- ◆ MoM avoids the unnecessary duplication of multicast packets on the foreign network in the event that the HA has multiple MHs present there

The tunnel convergence problem

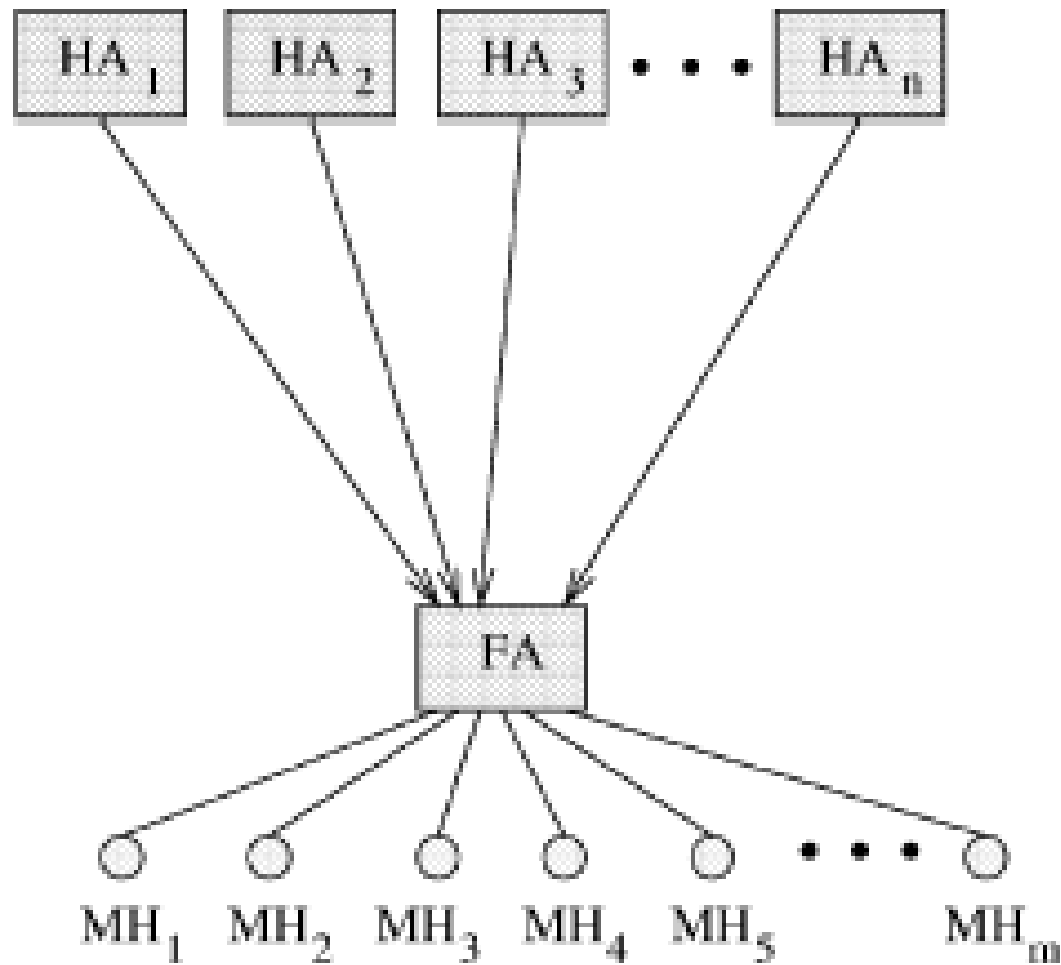

The tunnel convergence problem

- ◆ The foreign agent selects one home agent as the *designated multicast service provider* (DMSP) if a mobile host is the first mobile host to request subscription to group G at the foreign network
- ◆ The method solves the tunnel convergence problem , but it creates a handoff problem
 - Redundant DMSPs

Disruptions of multicast service

- ◆ When a mobile host moves
 - it moves to a foreign network that does not have an associated multicast router
 - ◆ Multicast service may be disrupted until the host moves again to a network with multicast capability
 - It moves from a foreign network to another network
 - ◆ Mobile IP there is no explicit deregistration with the foreign agent
 - HA – the mobile host reregisters at the new network
 - FA – timeout
 - ◆ a temporary disruption

MoM data structures

Home Agent Tables

Away Table

Host	FA	Timestamp

Group Information

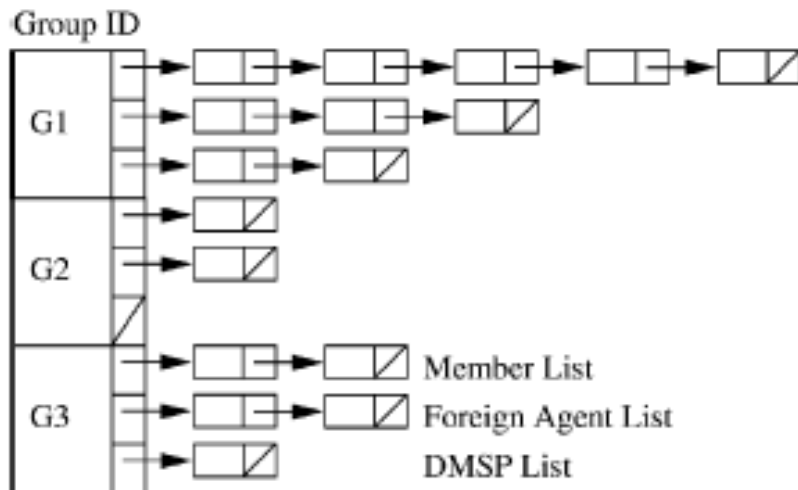

Foreign Agent Tables

Visitor Table

Host	HA	Timestamp

Group Information

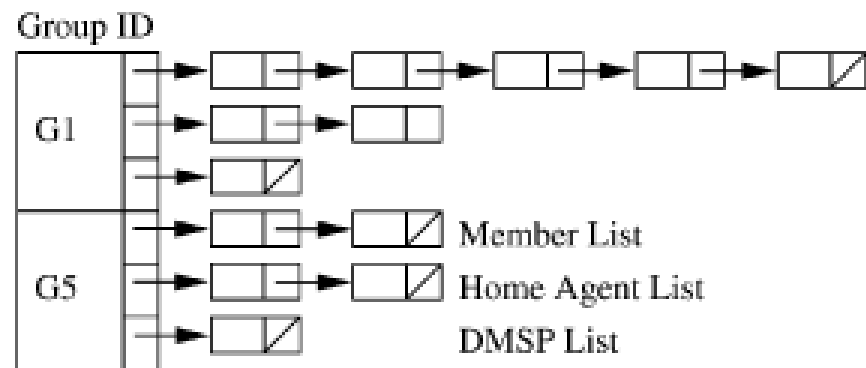

Protocol Detail

- ◆ Mobile host MH arrives at foreign network
- ◆ MH returns to its home network
- ◆ MH times out at a foreign network
- ◆ A unicast packet for MH arrives at MH's HA
- ◆ A multicast packet for group G arrives at HA
- ◆ A tunneled packet arrives at FA from HA

MH arrives at foreign network

1. Register with Foreign Agent (FA)
 - 1.1 Create Visitor Table entry for MH.
 - 1.2 Insert host name, HA info, and set timer.
 - 1.3 Notify FA of MH's current group memberships.
For each multicast group G that MH is in:
 - 1.3.1 Make entry in GroupInfoTable, if needed.
 - 1.3.2 Add MH to group membership list for G.
 - 1.3.3 If this is the first MH from that HA at this FA, then add the MH's HA to the HA list for group G, else increment the host count for the MH's HA.
 - 1.3.4 Select a DMSP for this group from HA list.
 - 1.3.5 If the chosen DMSP differs from the old DMSP then perform DMSP handoff.

MH arrives at foreign network (cont.)

2. Register with Home Agent (HA)
 - 2.1 Create or update Away Table entry for MH.
 - 2.2 Record oldFA, if any.
 - 2.3 Insert host name, FA info, and set timer.
 - 2.4 Notify HA of MH's group memberships.
For each multicast group G that MH is in:
 - 2.4.1 Make entry in GroupInfoTable, if needed.
 - 2.4.2 Add MH to G's membership list, if needed.
 - 2.4.3 If this is the first MH from this HA
at that FA, then add the MH's FA to the
FA list for group G, else increment the
host count for the MH's FA.
 - 2.4.4 If the MH's new FA differs from oldFA
then decrement host count for oldFA,
discarding oldFA from list if count is zero.
 - 2.4.5 Record/update DMSP status (YES/NO) of
HA for group G at FA (and oldFA, if needed).

MH returns to its home network

1. Notify the Home Agent (HA)
 - 1.1 Delete Away Table entry for MH, noting oldFA.
 - 1.2 For each multicast group G that MH is in:
 - 1.2.1 Delete MH from the membership list for G.
 - 1.2.2 Decrement the host count for MH's oldFA, discarding oldFA from FA list if count is zero, and deleting oldFA from DMSP list, if needed.

MH times out at a foreign network

1. Delete MH's entry from visitor list, noting HA.
2. For each multicast group G that MH is in:
 - 2.1 Delete MH from the membership list for G .
 - 2.2 Decrement the host count for MH's HA, discarding the HA from HA list if count is zero, and deleting the HA from the DMSP list, if needed.
 - 2.3 Select a DMSP from HA list for this group.
 - 2.4 If chosen DMSP differs from the old DMSP then perform DMSP handoff.

A unicast packet for MH arrives at MH's HA

1. Look up FA information for MH in Away Table.
2. Encapsulate packet and tunnel it to the FA.

A multicast packet for group G arrives at HA

1. Forward multicast packet to local members.
2. Look up membership information for the away members of that group.
3. Encapsulate packet and forward to each FA for which the HA is the DMSP for group G. This could be done using a separate Mobile IP unicast tunnel to each such FA, or as a multicast tunnel to the set of FAs for which the HA is the DMSP for group G.

A tunneled packet arrives at FA from HA

1. Decapsulate the packet.
2. If the packet is a unicast packet for a mobile host then forward to that host.
3. If the packet is a multicast packet for group G, then check for local members, and forward using link-level multicast if local members are found.

Comparison

A comparison of mobile multicast options.

Category	Remote subscription	Bi-directional tunneling	MoM
Optimal routing	Yes	No	No
Transparency	No	Yes	Yes
No Redundant packet delivery	Yes	No	Minimal
Delivery of scoped multicast	No	Yes	Yes
Multicast protocol independent	Yes	Yes	Yes
Join & graft delays	Yes	No	No
Foreign agent modification	No	No	Yes

Simulation

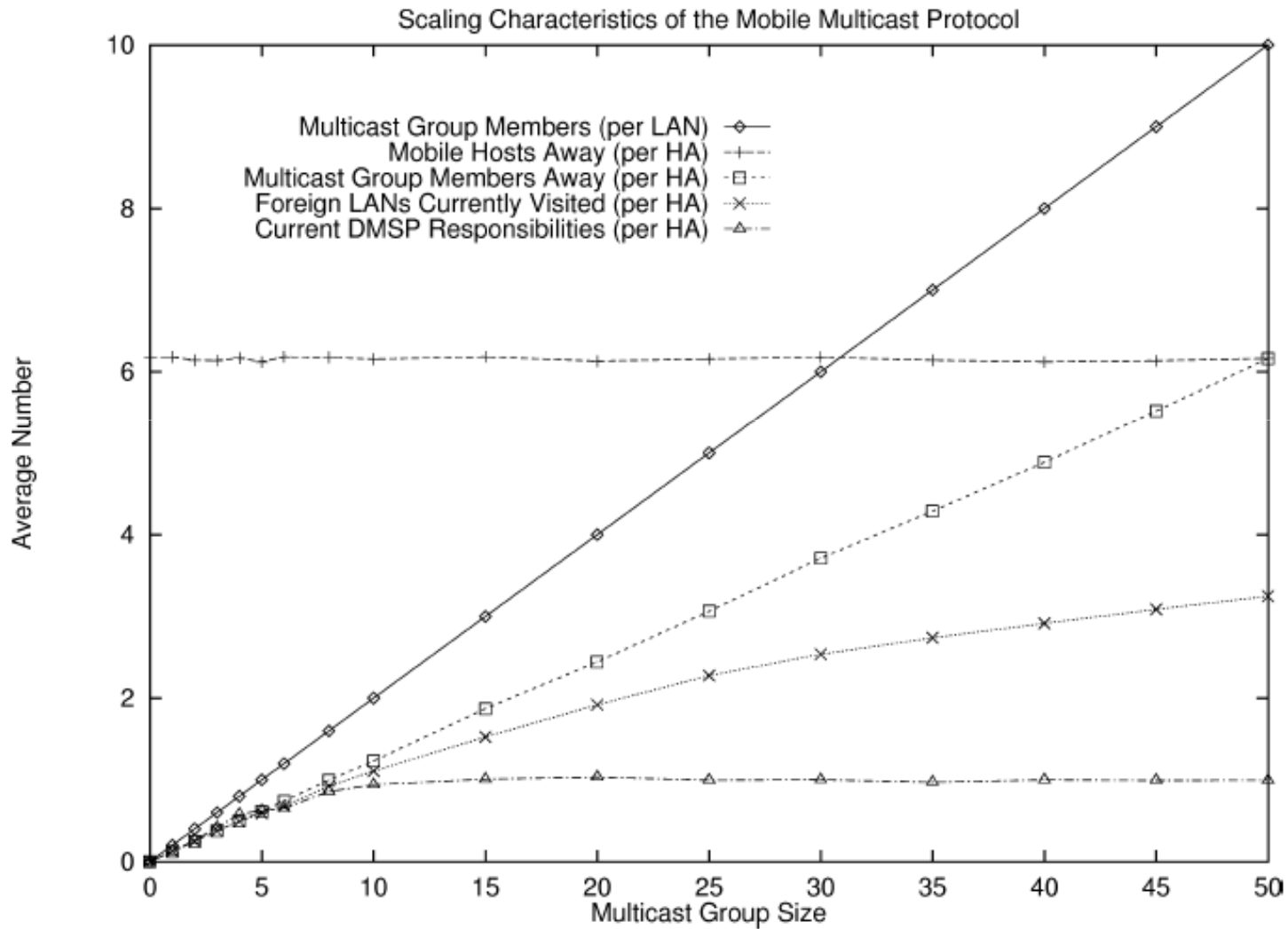

Limitations of MoM

- ◆ Packets that are sent and received by mobile hosts must always traverse the home network, making routing non-optimal
- ◆ Multiple unicasts are used by the home agent to tunnel multicast packets to foreign agents of mobile hosts that are group members

Advanced Approach (II)

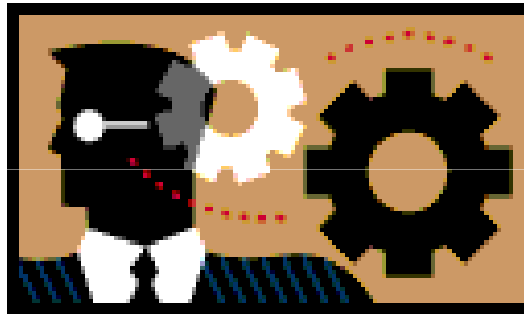

MMA (Mobile Multicast Agent)

Service Range Approach

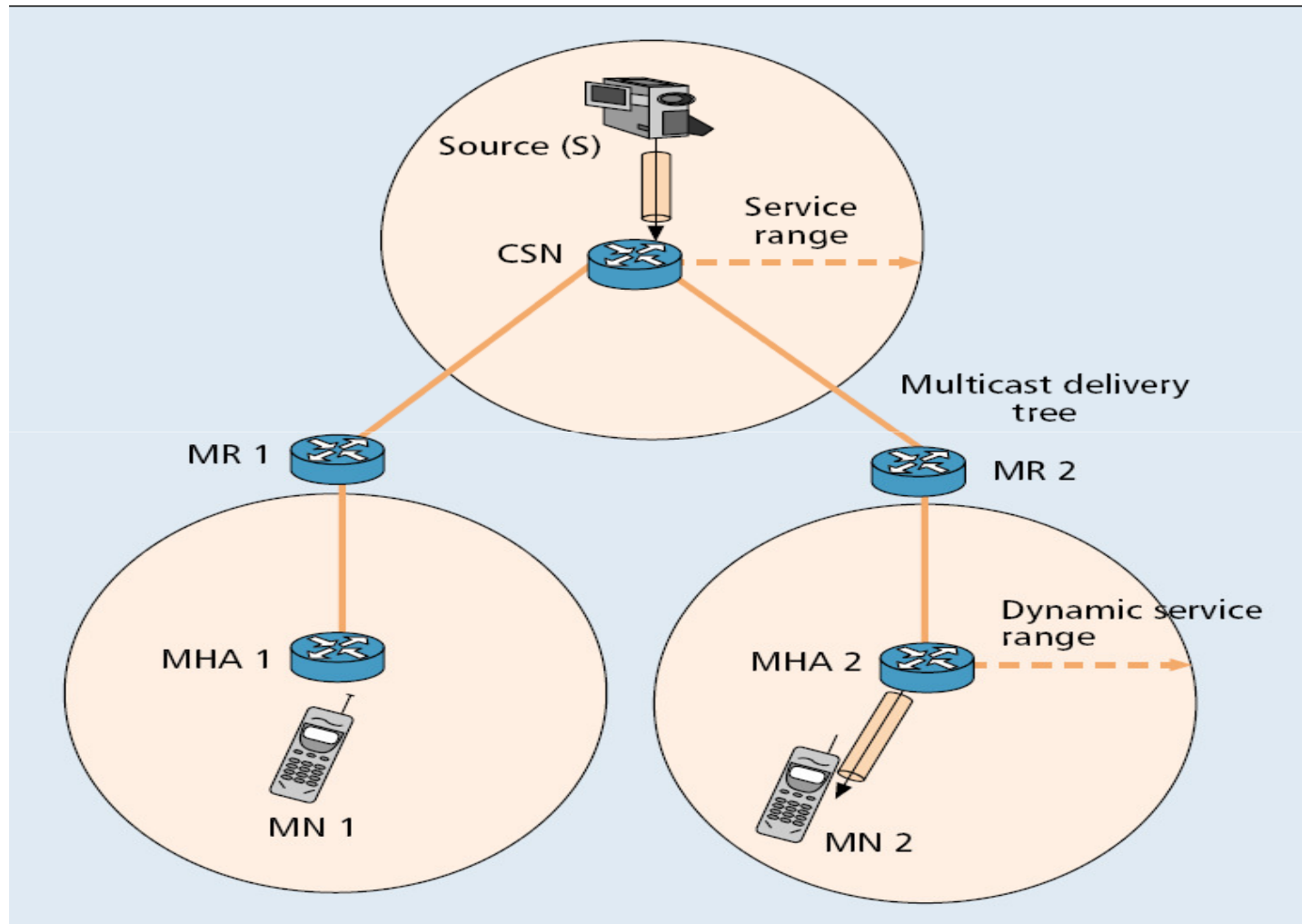

MMA Approach

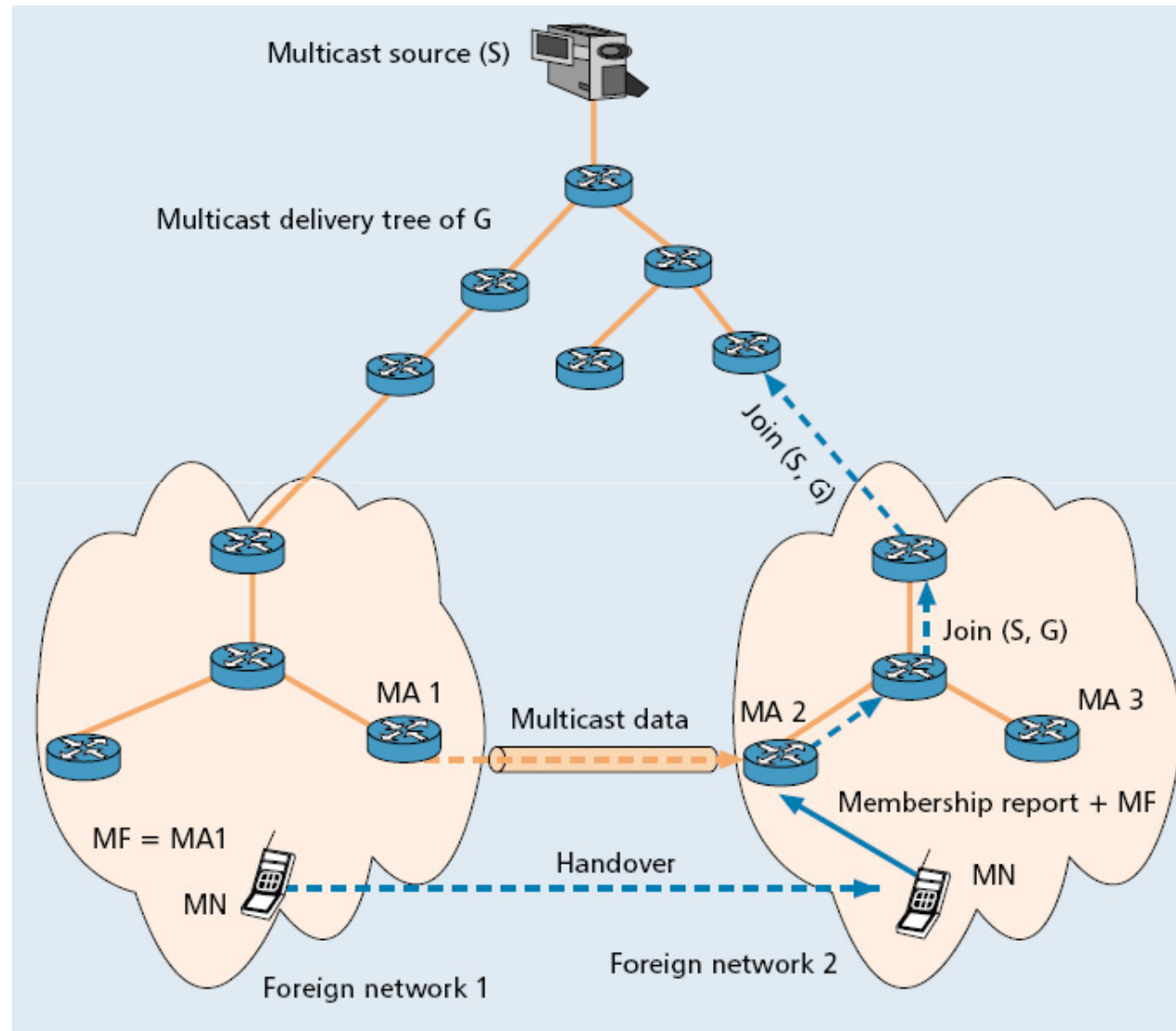

Challenge

- ◆ Optimal routing(Mobile-IPv4)
 - Use bind update packet
 - Home agent send this packet
- ◆ Optimal routing(Mobile-IPv6)
 - Use bind update packet
 - Mobile Node send this packet
 - ◆ (for loading of HA)

Mobile Multicast Gateway

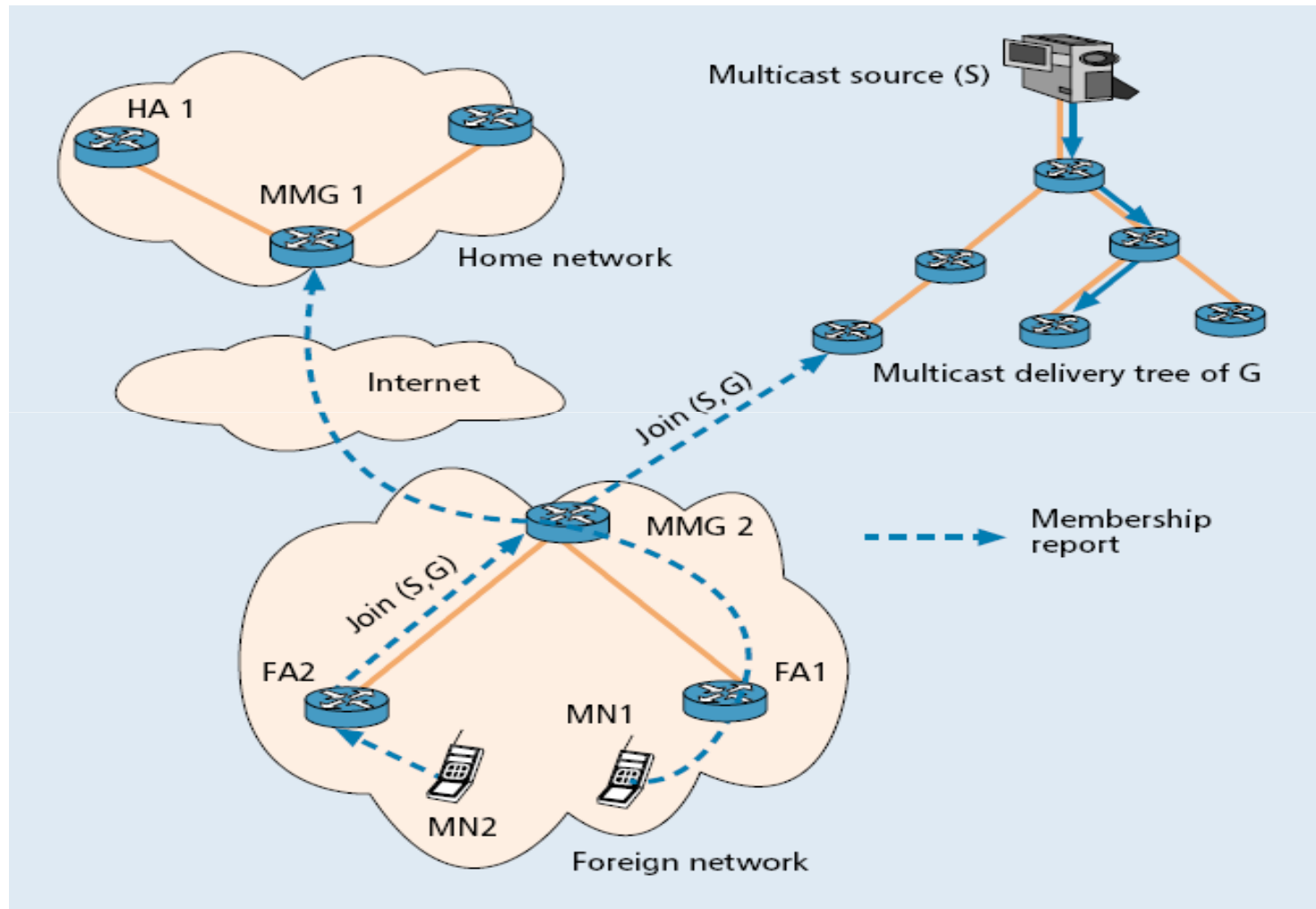

Introduction

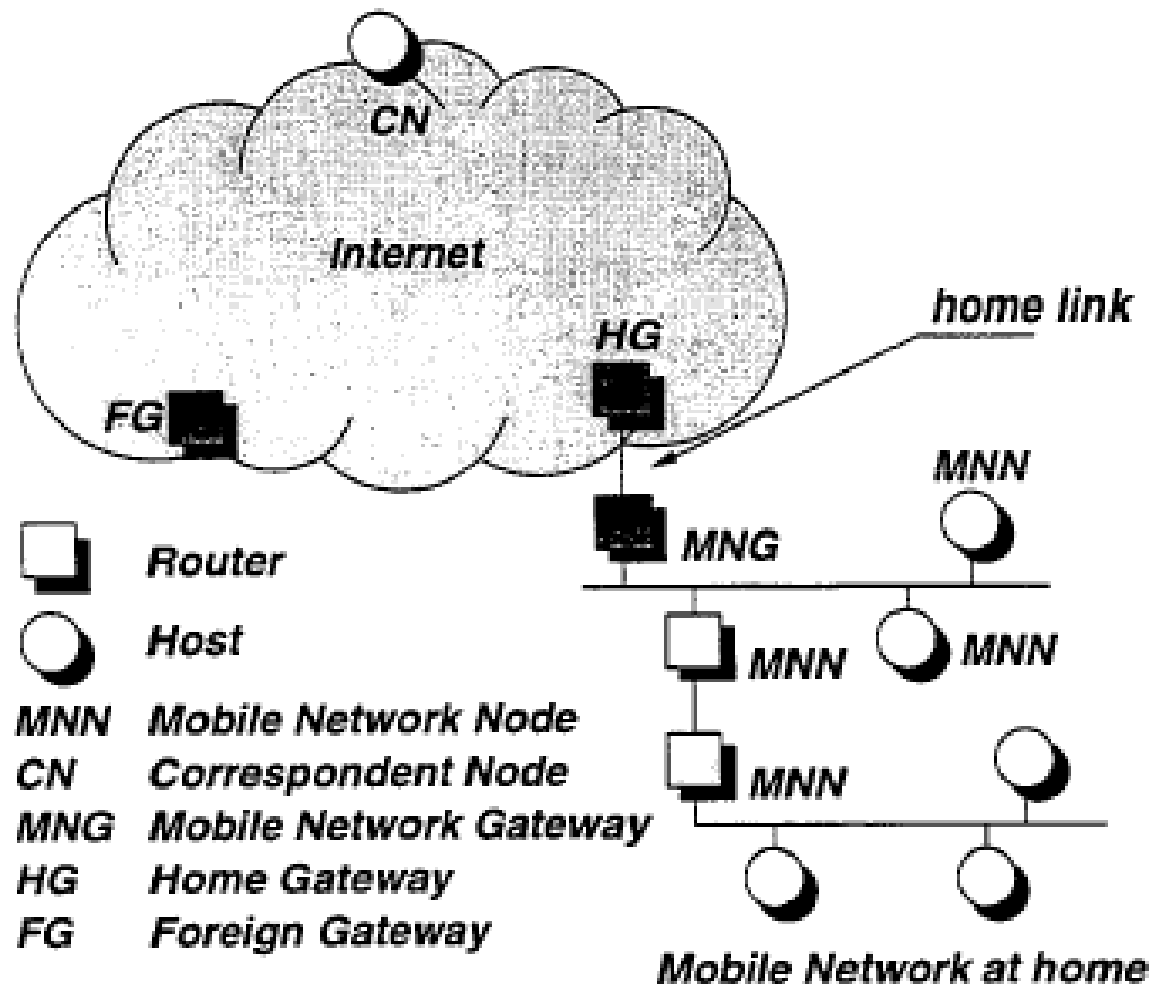

Introduction

