

Topic 9:

Ad hoc Network (Mesh Network)



Professor Eric Hsiaokuang Wu
May 13, 2005



Two Issues for Collaborative Computing

- ◆ Network Layer Collaborative:
 - Ad hoc- Infrastructure-less - support "anytime, anywhere"
 - To support communications between ad hoc nodes
 - ◆ To guide the packets effectively to satisfy different requirements
 - ◆ To adjust to dynamical topology change (due to Mobility)
- ◆ Application Collaborative:
 - Video Conferencing, News Broadcasting
 - Group of users to share the same information
 - Mobility Support

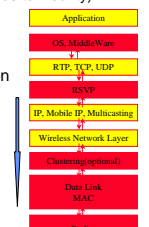

Trend Evolution

- ◆ IP success
 - The involvement and level of responsibility of end users have dramatically increased
 - The freedom has fueled creativity
- ◆ Infrastructure-less, self-organized networks
 - The network runs solely by operation of end users
 - Progress of electronic integration and wireless communication
 - Complement these infrastructures in cases where cost, constraints, or environment require self-organized solutions
 - Will be interconnected with the Internet and cellular networks



Mobile Computing to Pervasive Computing

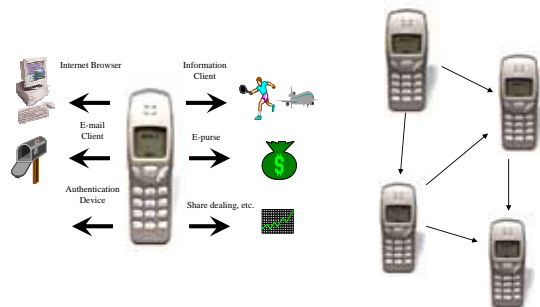

Mesh Network Scenario



Why not existing routing protocol

- ◆ Existing routing protocol search for shortest path not guarantee any QoS.

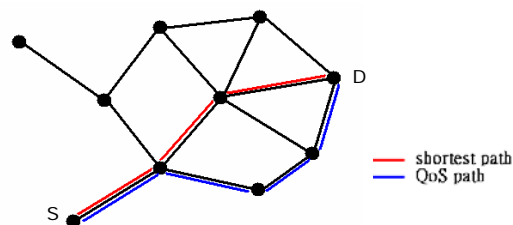

Bandwidth influence ~ hidden route problem

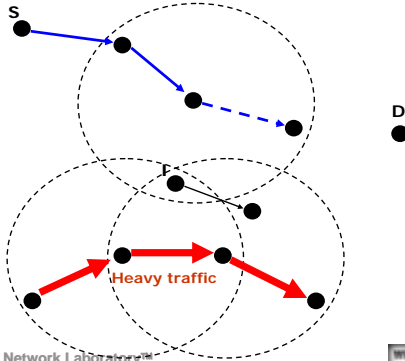

Traffic aggregation of existing flow

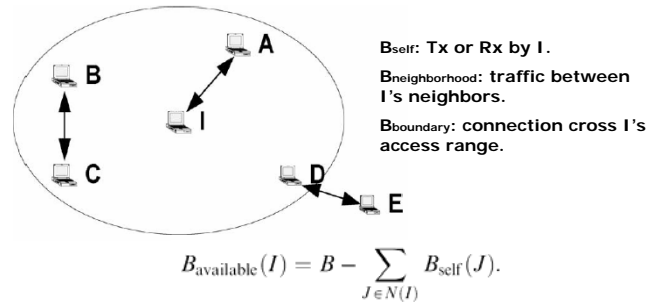

802.11 Bandwidth Estimation

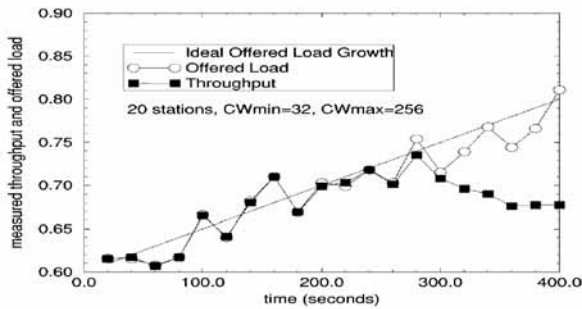
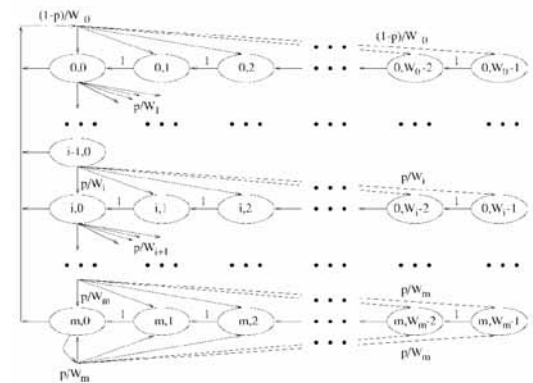

Fig. 3. Measured Throughput with slowly increasing offered load.

Markov chain model



Wir Fig. 3. Markov chain model for the backoff window size.

Observations

Personal Communications have been the dominant paradigm so far, but **mobile ad hoc networks** open new possibilities, such as the communication between objects



Survey of Ad hoc Researches

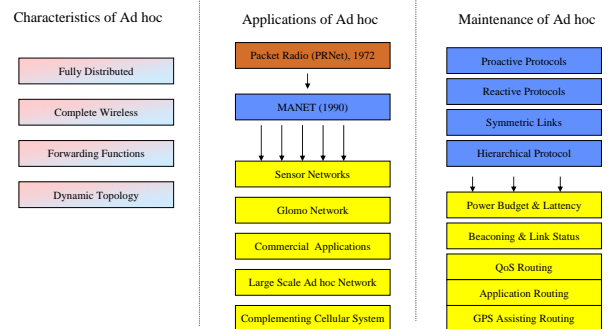

Reading



- ♦ [Jean2001] Jean-Pieere Hubaux, Thumas Gross, Jean-Yues Le Boudec, and Martin Vetterli, "Toward Self-Organized Mobile Ad Hoc Networks: The Terminodes Project"
- ♦ [Prasant 2003] Prasant Morhapatra, Jian Li, and Chao Gui, "QoS in Mobile Ad Hoc Networks", IEEE Wireless Communications, June 2003



Agenda



- ♦ Overview of Mobile Ad Hoc Networks
- ♦ Major Technical challenges:
 - Networking
 - Real time services
 - Software
- ♦ Long-term Research Project:
 - Terminodes Projects



Cellular based

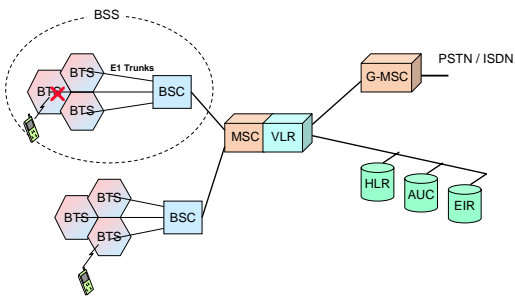

GSM Network Infrastructure



Ad-hoc network



- ♦ No centralized controller (base stations)
- ♦ No wired inter-connection backbone
- ♦ Forwarding function should be provided by mobile nodes

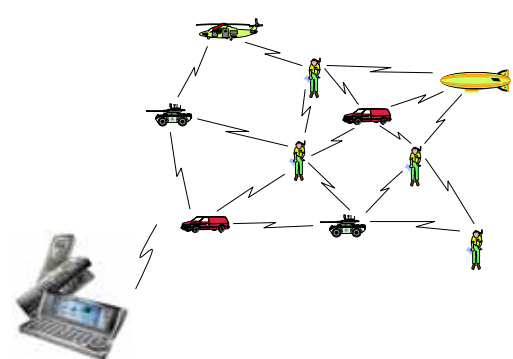
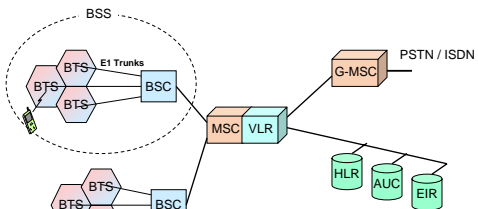
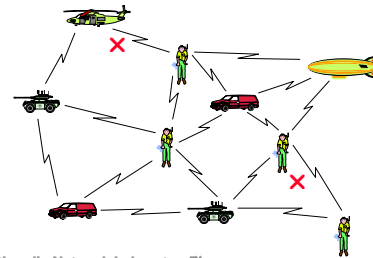

Mobility in Wireless LANs: Mobile IP

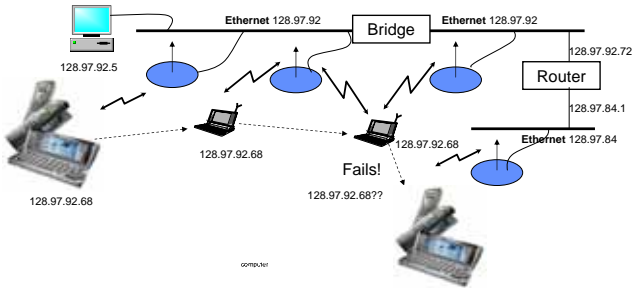

Wireless & Multimedia Network Laboratory™



QoS and Multimedia Traffic Support

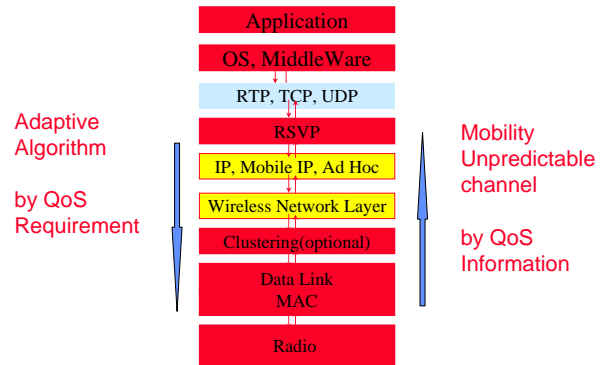

Wireless & Multimedia Network Laboratory™



Introduction



Self-Organized Mobile Ad Hoc Networks

Wireless & Multimedia Network Laboratory™



Overview (MANET)



- ◆ Packet Radio Networks ('70)
 - Research Results
 - ◆ Radio Resource Allocation
 - ◆ Network Organization
 - An Individual, handheld device
 - Military application (provide person-to-person communications on the battlefield)



Wireless & Multimedia Network Laboratory™



MANET



- ◆ Potential Applications:
 - Manmade disasters
 - Relief operation
 - Military applications
 - Car-based networks
 - Sensor networks
 - The Provision of wireless connectivity in remote areas
 - Collaborative Computing, Video Conferences



Wireless & Multimedia Network Laboratory™



MANET, Peculiarities



- ◆ They can act independent of any provider
- ◆ They have to be highly cooperative: The tasks are distributed over the nodes
- ◆ Any operation is the result of the collaboration of a group of them
- ◆ The nodes rely on batteries for their energy, energy saving
- ◆ Power aware: the set of functions offered by a node depends on its available power
- ◆ Highly dynamic topology
- ◆ Security is difficult to implement



Wireless & Multimedia Network Laboratory™



Technical Issues



- ◆ Routing
- ◆ Mobility Management
- ◆ IP Address
- ◆ Transport Layer
- ◆ Air Interface
- ◆ Security
- ◆ Power Management
- ◆ Standards and Products



Routing



- ◆ Ad hoc routing
 - Different from traditional solutions in the Internet or cellular phone networks (relative stable, distributed routing databases)
 - IETF (The Internet Engineering Task Force) MANET address the challenge
 - Distant vector, links state, source routing (table driven, on-demand)
 - Geographic methods: nodes are informed of their own geographic position



Routing Protocol



- ◆ Traditional Routing
 - Distance Vector (Bellman Ford)
 - Link State
- ◆ Ad Hoc Routing Protocols
 - DSDV
 - DSR
 - AODV
 - TORA



Traditional Routing



- ◆ Distance Vector (Table Driven)
 - Each node maintains its own routing table
 - Routing table contains
 - ◆ destination node index
 - ◆ next hop
 - ◆ metric
 - Periodic routing table exchange
- ◆ Disadvantage
 - Count-Infinity Problem
 - Convergence Problem

	A	B	C
B-A-1		A-B-1	B-C-1
C-B-2	B-B-1	C-B-1	A-B-2
	0	1	2
x	x	1	2
x	x	3	2
x	x	3	4
x	x	5	4
x	x	∞	∞



Traditional Routing (Cont.)



- ◆ Link State Routing
- ◆ Procedures
 - Neighbor Discovery
 - Routing Information Broadcast
 - Shortest Path Finding (e.g. Dijkstra's algorithm)

- ◆ Disadvantage
 - short-live looping problem

	0	1	2	3	4	5	6	7	8	9	10	11	12
0		X											
1	X												
2	X	X											
3	X	X	X										
4		X	X	X									
5			X	X									
6			X	X	X								
7		X	X	X	X								
8				X	X								
9					X	X							
10		X											
11							X	X					
12							X	X	X				

adjacency matrix



Ad Hoc Routing - DSDV



- ◆ DSDV
 - Destination Sequence Distance Vector Routing
 - Each route information is labeled with a increasing sequence number
 - ◆ Route info. with greatest number will be update
 - Route info. of broken link is broadcast with odd sequence one greater than the original sequence number
- ◆ Contribution
 - Main contribution of DSDV is freedom-loop guarantee
- ◆ Disadvantage
 - The periodic broadcast adds the overhead into the network



Ad Hoc Routing - DSR

CS/E

- ◆ DSR
 - Dynamic Source Routing
 - Route Discovery
 - ◆ Source node flooding routing request (RREQ) packet
 - ◆ Destination (inter-node) node reply RREP packet that piggybacks the route info.
 - ◆ Source node caches the route info
 - Route Maintenance
 - ◆ The route info. will be remove after receiving RERR packet
- ◆ Advantage
 - Requires no periodical routing exchange
- ◆ Disadvantage
 - packet is larger because of carrying route info.

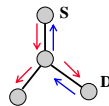

Wireless & Multimedia Network Laboratory™



Routing in ad hoc network environment only

CS/E

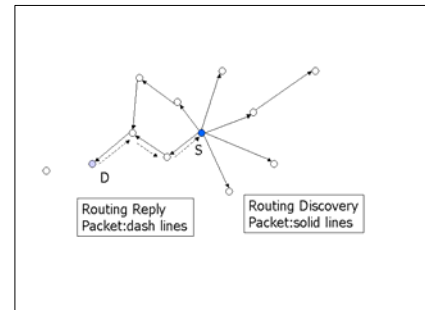

Wireless & Multimedia Network Laboratory™



Routing in heterogeneous environment

CS/E

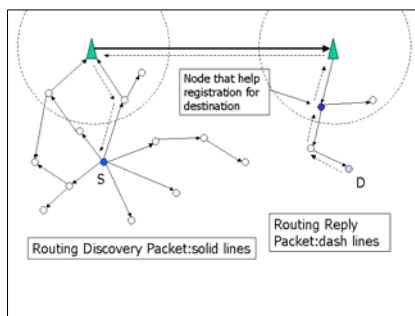

Wireless & Multimedia Network Laboratory™



Heterogeneous Network Support

CS/E

- ◆ Use of Interface Indices in DSR

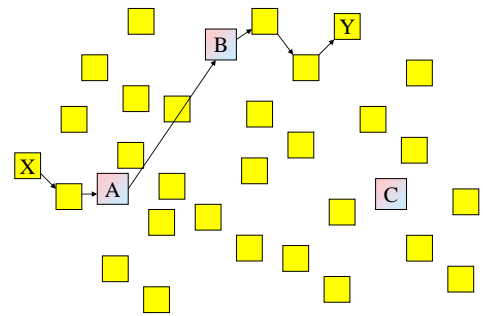

Wireless & Multimedia Network Laboratory™



Internet Interconnection and Mobile IP

CS/E

- ◆ DSR support the seamless interoperation between an ad hoc network and the Internet

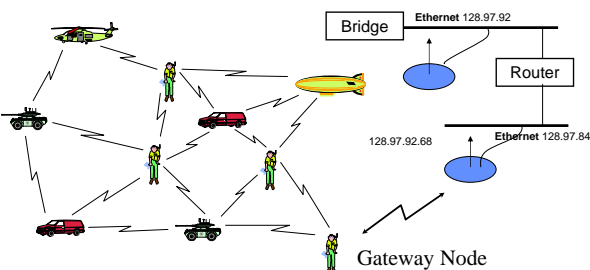

Wireless & Multimedia Network Laboratory™



On Demand Support Multicast & QoS

CS/E

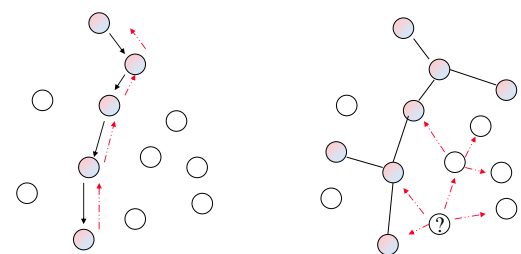

Bandwidth (QoS) Parameters

Multicast Join

Wireless & Multimedia Network Laboratory™



Ad Hoc Routing - AODV



- ◆ AODV
 - Ad-hoc On-demand Distance Vector
 - Shares the advantages of DSR and distance vector
 - Route Discovery
 - ◆ Similar to DSR
 - Route Maintenance - Table Entry
 - ◆ Destination IP, Destination Sequence, Hop Count, Next Hop, Life Time
 - The route info. Is invalid if
 - ◆ Life Time is expired
 - ◆ Receive RERR packet



Ad Hoc Routing - TORA



- ◆ TORA
 - Temporally-Ordered Routing Algorithm
 - Routing procedures
 - ◆ Flood QUERY packet
 - ◆ UPDATE packet will be broadcast from destination or inter-node
 - ◆ HEIGHT info. is appended to UPDATE packet
 - ◆ the node receives UPDATE packet set its height and the forwarding UPDATE packet's height to a value one greater than original one
 - Source node send data to the destination via neighbor that have lower height with respect to the destination
- ◆ Advantage
 - Minimizes the reaction due to changes of network topology
- ◆ Disadvantage
 - Depend on Internet MANET encapsulation Protocol, the overhead is large



Ad Hoc Routing - TORA (Cont.)

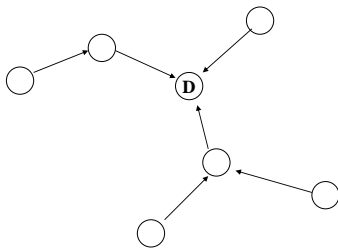

Directed acyclic graph rooted at destination



ABR (Associativity-Based Routing)



- ◆ ABR considers the stability of a link.
 - The metric is called **degree of association stability**.
- ◆ Basic Idea:
 - Each node periodically generates a beacon to signify its existence.
 - On receipt of the beacon, a neighboring node will increase the "tick" of the sender by 1.
 - ◆ A higher degree of association stability (i.e., ticks) may indicate a low mobility of that node.
 - ◆ A low degree of association stability may indicate a high mobility of that node.
 - When a link becomes broken, the node will set the tick of the other node to 0.



ABR Outline



- ◆ Route Discovery:
 - (similar to DSR)
 - ◆ On needing a route, a host will broadcast a ROUTE_REQUEST packet.
 - ◆ Each receiving host will append its address to the packet.
 - The **association stability** (represented by "ticks") is also appended in the ROUTE_REQUEST packet.
 - The destination node will select the **best route** (in terms of association stability), and then respond a packet to the source.

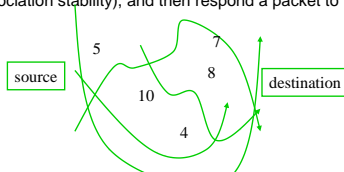

- ◆ Route Reconstruction:
 - On route error, a node will perform a local search in hope of rebuild the path.
 - If the local search fails, a ROUTE_ERROR will be reported to the source.

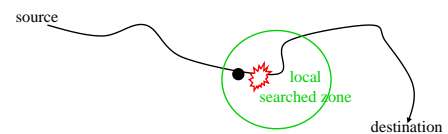

Mobility Management



- ◆ Broadcasting a paging message the whole network: won't scale well
- ◆ Different from centralized servers (either HLR in GSM), location must be distributed among the nodes
- ◆ Prediction of the future locations

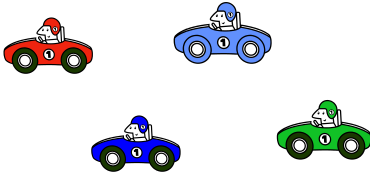

Radio Interface



- ◆ CSMA/CA: hidden terminal

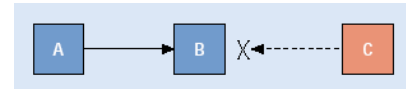

- ◆ Defining master and slaves roles: Bluetooth



MACA/PR



- ◆ The key component
 - the MAC protocol for data transmission
 - Reservation scheme for real-time connection setup
 - QoS Routing algorithm



MACA/PR - MAC



- ◆ Data-gram Traffic
 - RTS - CTS - PKT - ACK
 - <RTS,CTS> for hidden terminal avoidance, ACK for retransmission
- ◆ Real-Time Traffic
 - < RTS - CTS > - PKT - ACK
 - <RTS,CTS> used for first time transmission to set up the reservation
 - ACK for renewing the reservation, not recovery



MACA/PR - Reservation/QoS Routing



- ◆ CYCLE is the max. interval allowed between two real-time packets
- ◆ Each node maintains its own reservation table
- ◆ DSDV routing is employed
- ◆ Bandwidth info. can be easily obtained via reservation table

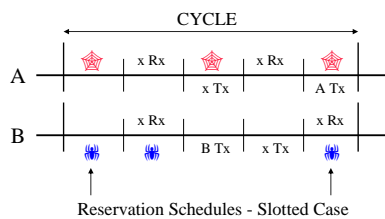

MACA/PR - Properties



- ◆ Asynchronous approach
- ◆ Low latency, low packet loss rate
 - Hidden Terminal Problem is solve automatically
- ◆ Fair bandwidth sharing
- ◆ Good mobility handling
 - Maintain secondary routing path
- ◆ Low implementation costs



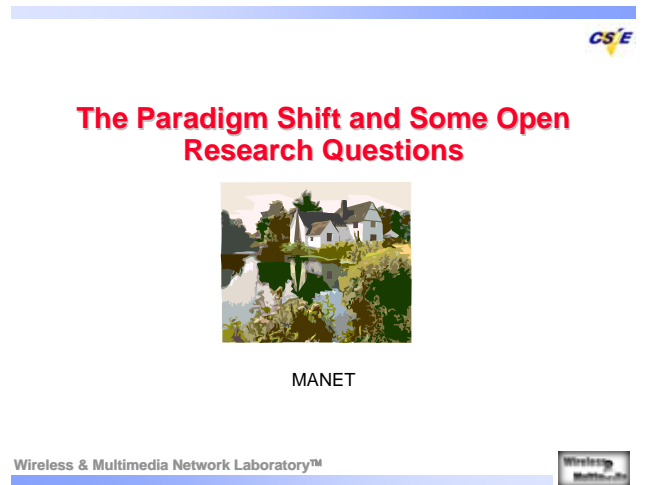
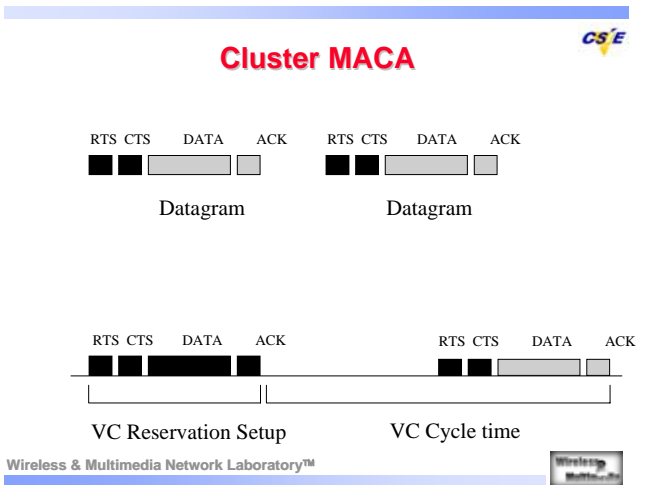
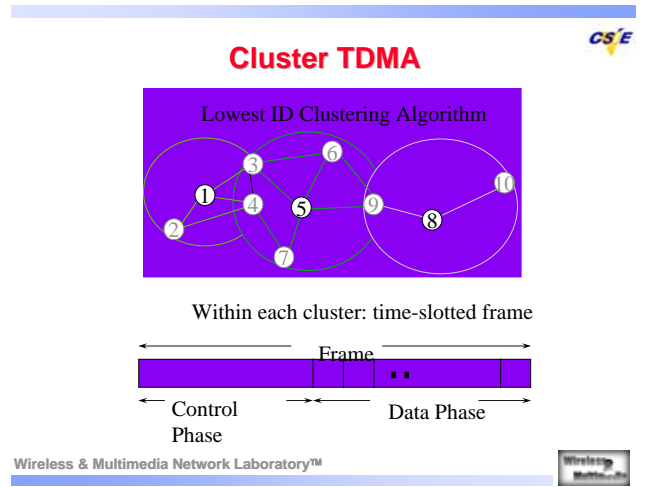
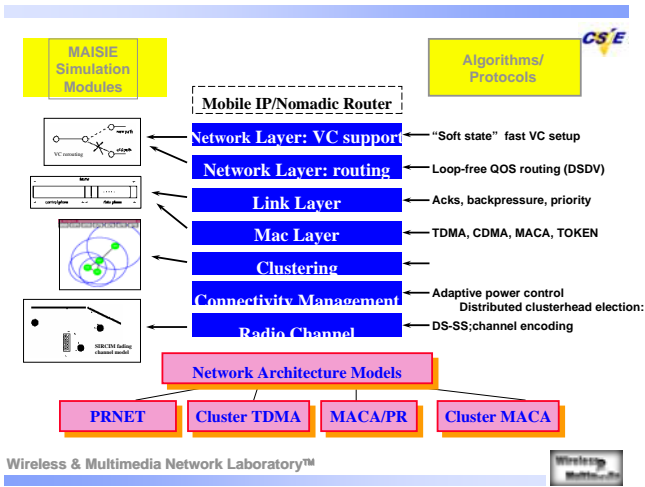

- ### Terminodes Projects
- ◆ Large scale self-organized mobile ad hoc networks
 - ◆ All layers and interlay interactions
 - From physical layer up to software architecture and applications
 - ◆ Try to capture the business and societal potential
 - ◆ Three levels:
 - Technical challenges
 - Intellectual fantasy
 - Societal/political vision
- Logos for CS/E and Wireless & Multimedia Network Laboratory are present.

- ### Terminodes
- ◆ Networking Issues
 - Scalability
 - ◆ Virtual Currency
 - Obligation
 - ◆ Real Time Services
 - QoS
-
- Logos for CS/E and Wireless & Multimedia Network Laboratory are present.

Networking Issues

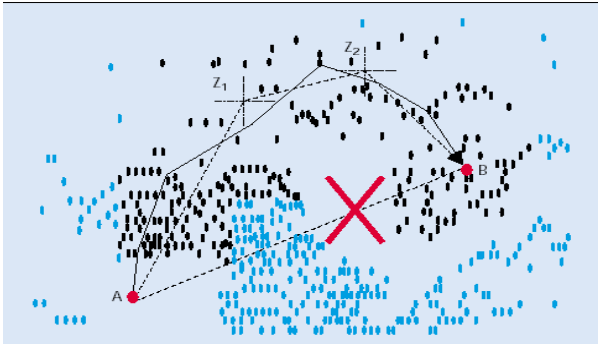

Wireless & Multimedia Network Laboratory™



Routing for Terminode



- ◆ Each Terminode has
 - A permanent unique node identifier, EUI (End System Unique Identifier)
 - Location-Dependent Address (LDA)
- ◆ Geodesic Packet Forwarding:
 - The packet is forwarded to the neighbor closest to the direction in which the destination is located
- ◆ Terminode local routing
 - MANET routing (link State, Distance Vector, Source Routing)

Wireless & Multimedia Network Laboratory™



Networking Issues

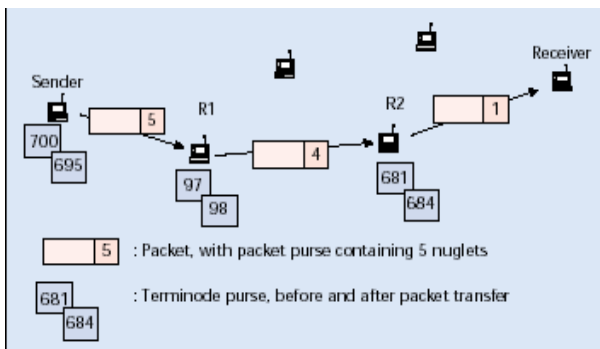

Wireless & Multimedia Network Laboratory™



Virtual Currency (Nuglet)



- ◆ Service Availability is a major requirement for self-organization
- ◆ The End users must be given incentive to cooperate
- ◆ They must be encouraged to not overload the network



Wireless & Multimedia Network Laboratory™



Multiple description coding

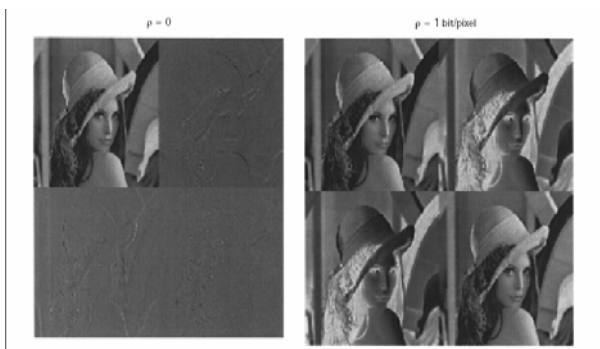

Wireless & Multimedia Network Laboratory™



Real-Time Services over Ad hoc Networks



- ◆ Real-Time Services
 - Voice or video over ad hoc networks
 - Unreliable \leftrightarrow stringent delay
 - Large error, node failure
- ◆ Redundancy, error correction codes over parallel connections

Wireless & Multimedia Network Laboratory™



Software Aspects



- ◆ Software implementations:
 - Base software: Routing algorithms, accounting system and security system
 - Application software: Software that makes a collection of terminodes useful for a client
 - Flexible software architectures
- ◆ Resource Allocations
 - Contract
 - Loader
 - Dynamic checks



Discussions



- ◆ Three Networks:
 - Telecom networks
 - The Internet
 - Self-Organized Mobile Ad Hoc Networks

Network	Infrastructure	Security	Applications
Telecom networks	Telcos	Telcos	Telcos (IN)
Internet	ISPs + telcos	ISPs + users (PGP)	Users
Self-org. ad hoc NW	Users + vendors	Users + vendors	Users

