

無線網路多媒體系統 Wireless Multimedia System



Dr. Eric Hsiaokuang Wu
WiMAX & UWB

<http://inrg.csie.ntu.edu.tw/course/wms>
2005 Spring



WiMAX Consumer Last Mile

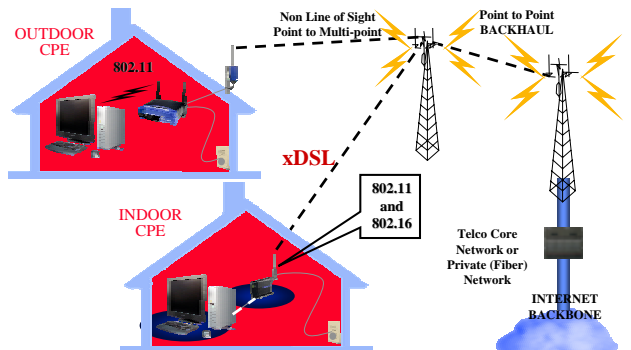

Ref: Margaret LaBrecque, "Enabling Deployments through Standards and Certification,"
WiMax, 2003
Wireless & Multimedia Network Laboratory™

WiMAX Nomadic and Portable



Ref: Margaret LaBrecque, "Enabling Deployments through Standards and Certification,"
WiMax, 2003



Wearable Computing

- Traditional Scenario
 - People wear sensors now routinely
 - Primarily for fashion or as indicators
- Wearable computing
 - Interaction with computer or other personal device
 - Interaction in an intelligent environment
 - Interaction with other people

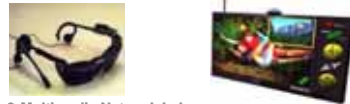

What is Ultra Wideband?

- Originally referred to
 - "baseband", "carrier-free", or impulse
- Any wireless transmission scheme
 - occupies a bandwidth of more than 25% of a center frequency, or more than 1.5GHz

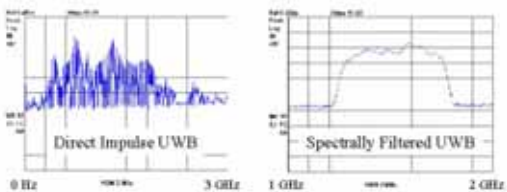

Compare with IEEE 802.11 and Bluetooth

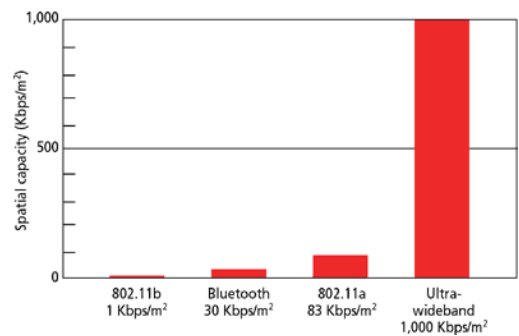

The Wireless Home Network

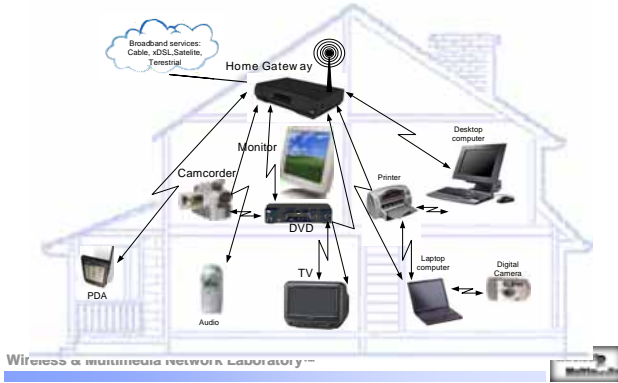

Multi-Cluster Home Network

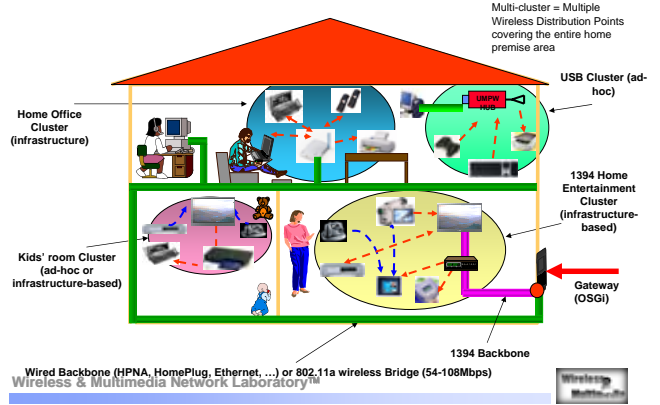

Topic I

WiMAX: IEEE 802.16



Professor Eric Hsiao Kuang Wu
June 10, 2005



Broadband Access to Buildings



- ◆ The "Last Mile"
 - Fast local connection to network
- ◆ Business and residential customers demand it
 - Data, voice, video distribution, real-time video conferencing
- ◆ Network operator demand it
- ◆ High capacity cable/fiber to every user is expensive



Introduction



- ◆ Goal: Provide high-speed Internet access to home and business subscribers, without wires.
- ◆ Base stations (BS) can handle thousands of subscriber stations (SS)
- ◆ Access control prevents collisions.
- ◆ Supports
 - Legacy voice systems
 - Voice over IP
 - TCP/IP
 - Applications with different QoS requirements



Introduction



- ◆ 802.16 standards:
 - 802.16.1 (10-66 GHz, line-of-sight, up to 134Mbit/s)
 - 802.16.2 (minimizing interference between coexisting WMANs.)
 - 802.16a (2-11 GHz, Mesh, non-line-of-sight)
 - 802.16b (5-6 GHz)
 - 802.16c (detailed system profiles)
 - P802.16e (Mobile Wireless MAN)



Point to Multipoint



- ◆ BS connected to public networks
- ◆ BS serves Subscriber Stations (SSs)
 - SS typically serves a building (business or residence)
 - Provide SS with first-mile access to public networks
- ◆ Compared to a Wireless LAN
 - Multimedia QoS, not only contention-based
 - Many more users
 - Much higher data rates
 - Much longer distances



WirelessMAN: Wireless Metropolitan Area Network

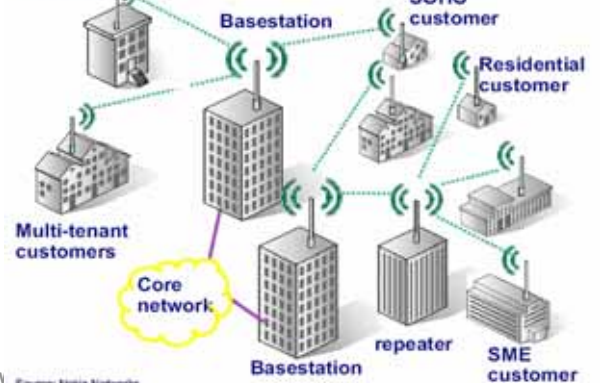

Modulation Types



MAC Layer



- ◆ MAC is comprised of 3 sublayers
 - Service Specific Convergence Sublayer
 - MAC Common Part Sublayer
 - Privacy Sublayer



Service Specific Convergence Sublayer



- ◆ Classing SDUs and associate them to the proper MAC service flow and CID
- ◆ Support various protocols
- ◆ Internal format of CS payload is unique to the CS



MAC Common Part Sublayer



- ◆ Provides the core MAC functionality
 - Bandwidth allocation
 - Connection establishment
 - Connection maintenance
- ◆ During initialization of an SS, 3 particular connections are established in both direction
 - Basic connection: short time critical
 - Primary management connection: longer more delay
 - Second management connection: higher layer management and SS configuration data



MAC PDU Formats



- Two header formats are defined
 - Generic header
 - Bandwidth request header
- Three types of MAC subheader
 - The grant management: used by an SS to convey bandwidth management
 - The fragmentation: indicate the presence and orientation in the payload of any fragmentation of SDUs
 - The packing: indicate the packing of multiple SDUs into a single PDU



Transmission of MAC PDUs

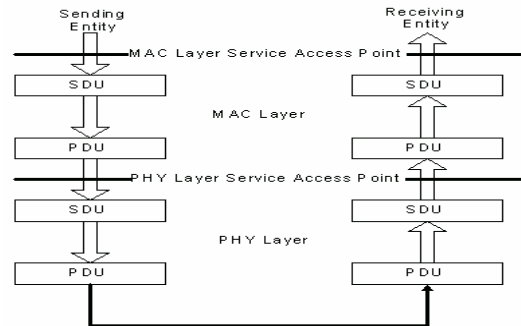

4 types of Scheduling Service



- Unsolicited Grant Service (UGS)
 - Real-time, periodic fixed size packets (e.g. T1 or VoIP)
 - Restrictions on bw requests (Poll-Me bit)
 - Slip Indicator (SI)
- Real-Time Polling Service (rtPS)
 - Real-time, periodic variable sizes packets (e.g. MPEG)
 - BS issues periodic unicast polls.
 - Cannot use contention requests, but piggybacking is ok.
- Non-Real-Time Polling Service (nrtPS)
 - Variable sized packets with loose delay requirements (e.g. FTP)
 - BS issues unicast polls regularly (not necessarily periodic).
 - Can also use contention requests and piggybacking.
- Best Effort Service
 - Never polled individually
 - Can use contention requests and piggybacking

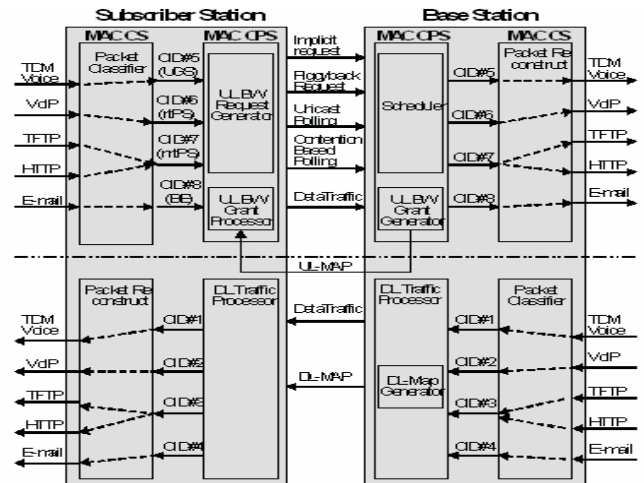

Physical Layer



- "Burst single-carrier" modulation
- Allows use of directional antennas
- Allows use of two different duplexing schemes:
 - Frequency Division Duplexing (FDD)
 - Time Division Duplexing (TDD)
- Support for both full and half duplex stations



- Adaptive Data Burst Profiles
 - Transmission parameters (e.g. modulation and FEC settings) can be modified on a frame-by-frame basis for each SS.
 - Profiles are identified by "Interval Usage Code" (DIUC and UIUC)



- ◆ Connection oriented
 - Connection ID (CID), Service Flows(SF)
- ◆ Channel access
 - UL-MAP
 - ◆ Defines uplink channel access
 - ◆ Defines uplink data burst profiles
 - DL-MAP
 - ◆ Defines downlink data burst profiles
- UL-MAP and DL-MAP are both transmitted in the beginning of each downlink subframe (FDD and TDD).



TDD Downlink subframe

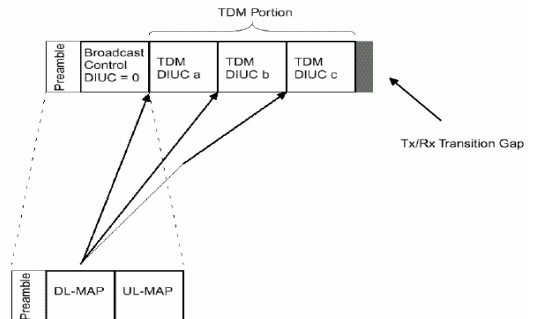

FDD Downlink subframe

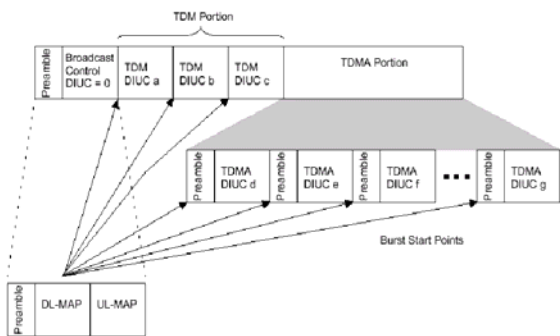

FDD burst framing

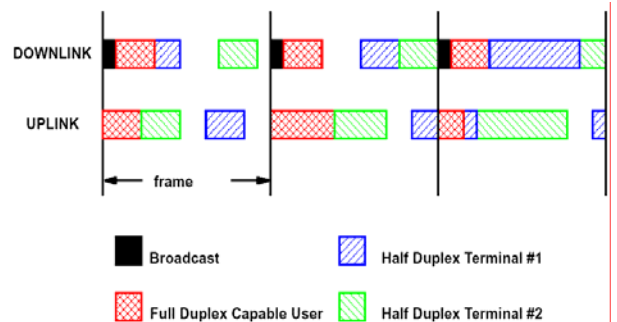

Uplink subframe(TDD or FDD)

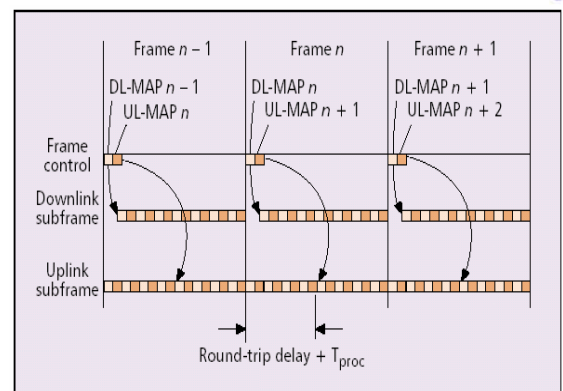
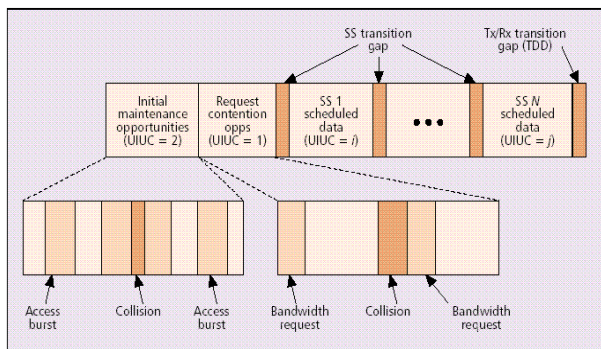

Uplink periods



- ◆ Initial Maintenance opportunities
 - Ranging
 - To determine network delay and to request power or profile changes.
 - Collisions may occur in this interval
- ◆ Request opportunities
 - SSs request bandwidth in response to polling from BS.
 - Collisions may occur in this interval as well.
- ◆ Data grants period
 - SSs transmit data bursts in the intervals granted by the BS.
 - Transition gaps between data intervals for synchronization purposes.



Bandwidth request and allocation



- ◆ SSs may request bw in 3 ways:
 - Use the "contention request opportunities" interval upon being polled by the BS (multicast or broadcast poll).
 - Send a standalone MAC message called "BW request" in an already granted slot.
 - Piggyback a BW request message on a data packet.



Bandwidth request and allocation



- ◆ BS grants/allocates bandwidth in one of two modes:
 - Grant Per Subscriber Station (GPSS)
 - Grant Per Connection (GPC)
- ◆ Decision based on requested bw and QoS requirements vs available resources.
- ◆ Grants are realized through the UL-MAP.



Unicast Polling

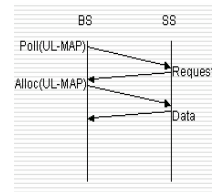

1. BS allocates space for the SS in the uplink subframe.
2. SS uses the allocated space to send a bw request.
3. BS allocates the requested space for the SS (if available).
4. SS uses allocated space to send data.



Topic II

UWB: Next Generation Technology for Wireless Personal Area Network



Professor Eric Hsiaokuang Wu
June 10, 2005



Outline



- ◆ What is UWB?
- ◆ Applications and Market
- ◆ Overview of IEEE 802.15.3 MAC



Definition of FCC



$$\text{fractional bandwidth} = \frac{2(f_H - f_L)}{f_H + f_L} > 0.25$$

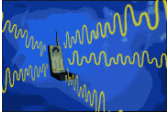

UWB vs. Narrow Band

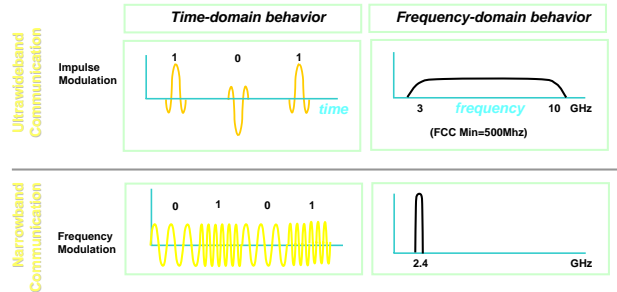

UWB Spectrum



- FCC ruling permits UWB spectrum overlay

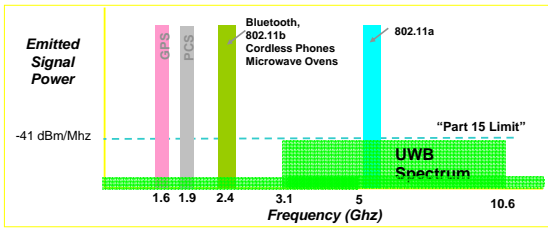

Advantages: Multi-path Immunity

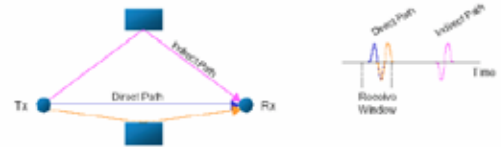

Advantages: Very High Data Rate



- Shannon's Channel Capacity Theorem:

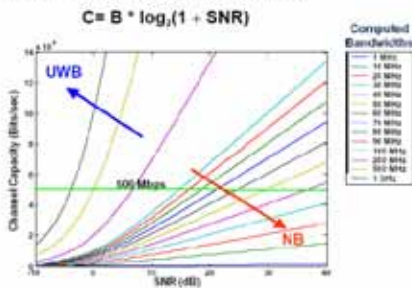

Cont.

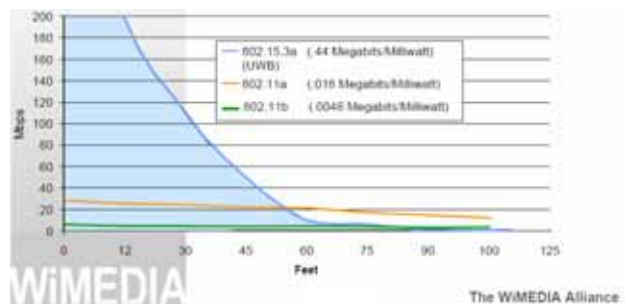

Advantages: High Spatial Capacity



Spatial Capacity Limitations

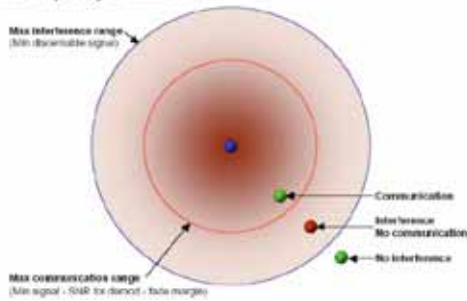

Wireless & Multimedia Network Laboratory™



Cont.



The UWB Advantage

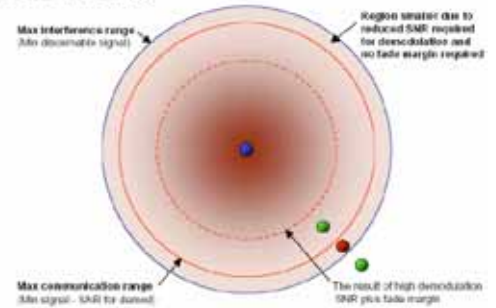

Wireless & Multimedia Network Laboratory™



Cont.



UWB Using Rake Receiver

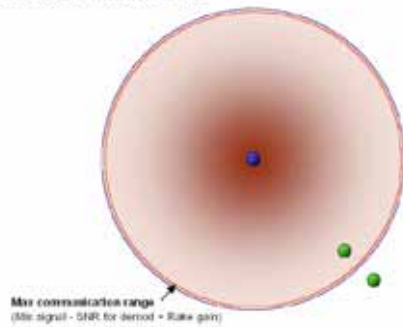

Wireless & Multimedia Network Laboratory™



Advantages: More Precise Ranging



UWB Ranging via Two-Way Time Transfer[®]

Results are Independent of "Turnaround-Time Latency"

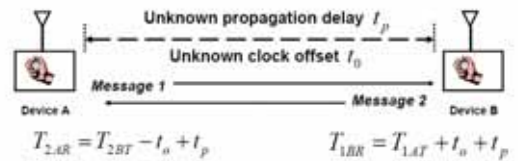

Two equations in two unknowns yield:

$$t_p = \frac{1}{2} [(T_{2,AR} - T_{1,AT}) - (T_{2,BT} - T_{1,BR})]$$

$$t_o = \frac{1}{2} [(T_{2,BT} + T_{1,BR}) - (T_{2,AR} + T_{1,AT})]$$

Wireless & Multimedia Network Laboratory™



IEEE 802.15.3a Debate



- ♦ Sept. 2003 – IEEE conference results in 60% approval for OFDM
- ♦ TI/Intel (MB-OFDM) vs. Motorola/XtremeSpectrum (DS-SS)
- ♦ 75% needed for acceptance
- ♦ Compatibility issues

Wireless & Multimedia Network Laboratory™



Applications and Market



Wireless & Multimedia Network Laboratory™



Applications



- ◆ Positioning, Geolocation, Localization
- ◆ Communications
- ◆ Radar/Sensor



INTEL: Wireless USB (Home)

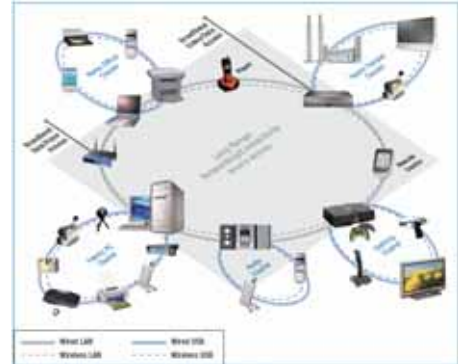

Office



Some Top Candidates for Wireless USB Devices in the Office:

- Digital Projector
- Headset and Speakers
- Mass Storage (HDD, DVD-RW, CD-RW, etc.)
- Mobile Phone
- PC Camera
- PDA
- Printer
- Scanner



Topology Required

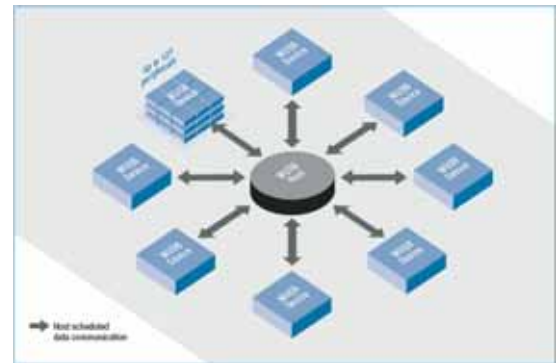

WiMedia Solutions – Simple Usage



WiMedia-Enabled Family Room



WiMedia Hybrid Network 'Personal Operating Space'

CS'E



Wireless & Multimedia Network Laboratory™



CS'E

IEEE 802.15.3 MAC

Wireless & Multimedia Network Laboratory™



IEEE 802 LAN / MAN Standards Committee (Wireless Areas)

CS'E

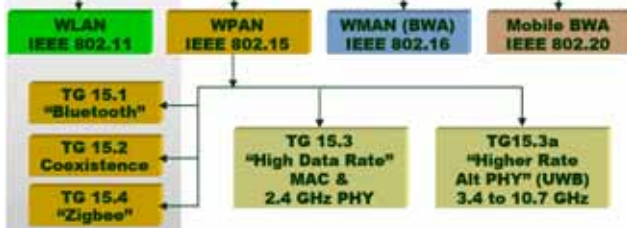

Wireless & Multimedia Network Laboratory™



CS'E

WPAN

- ♦ **Wireless Personal Area Network**
 - A wireless personal area network (WPAN) is a wireless ad hoc data communications system which allows a number of independent data devices to communicate with each other. A WPAN is distinguished from other types of data networks in that communications are normally confined to a person or object that typically covers at least 10 meters in all directions and envelops the person or a thing whether stationary or in motion.
- ♦ **Piconet**
 - A set of devices within a personal operation space operating under the control of a piconet controller (PNC) in order to share a wireless resource. The PNC always provides the basic timing for the WPAN. Additionally the PNC manages the quality of service (QoS) requirements of the WPAN.

Wireless & Multimedia Network Laboratory™



WPAN Topology

CS'E

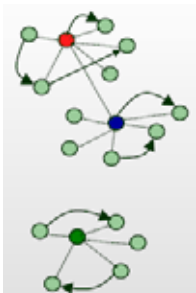

- Parent Piconet Controller
- Piconet Device
- Child/Neighbor Piconet Controller
- Piconet Relationship
- Peer to Peer Data Transmission
- Independent Piconet Controller

Wireless & Multimedia Network Laboratory™



Piconet Superframe

CS'E

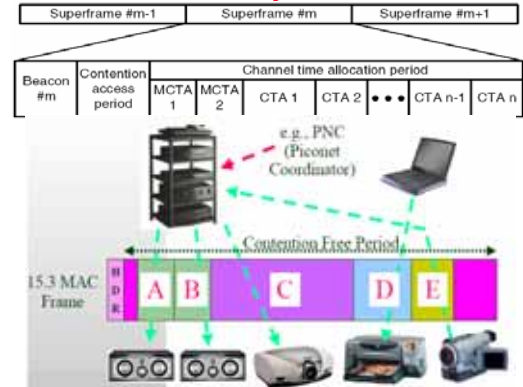

Wireless & Multimedia Network Laboratory™



Main Characteristics



- ◆ **High Rate WPAN:**
 - Short Range (at least 10m)
 - High Data rates
 - ◆ 15.3 PHY 20-55 Mbps
 - ◆ 15.3a PHY 110-480 Mbps
- ◆ **Dynamic Topology:**
 - Mobile devices often join and leave piconet
 - Short time to connect (<1s)
- ◆ **Ad-hoc network with Multimedia QoS provisions**
 - TDMA for streams with time based allocations
 - Peer to peer connectivity
- ◆ **Multiple Power Management Modes:**
 - Designed to support low power portable devices



Cont.



- ◆ **Low price point, low complexity and small form factor**
 - Embedded in mobile device
 - USB/1394 Dongle
- ◆ **Secure Network:**
 - Authentication using higher layer protocol (PK or other)
 - Dynamic key distribution
 - Shared Key encryption (AES 128) and integrity (data and commands) - CCM
- ◆ **Ease-of-use:**
 - Dynamic coordinator selection and handover
 - Does not rely on a backbone network



Starting Piconets - Scan

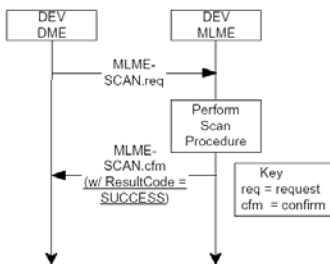

- Open scan
- Non-open scan



Detect Another Piconet



- ◆ Changing to a different channel.
- ◆ Become a child or neighbor piconet of the other piconet.
- ◆ Reduce the piconet's transmit power.



Starting a Piconet

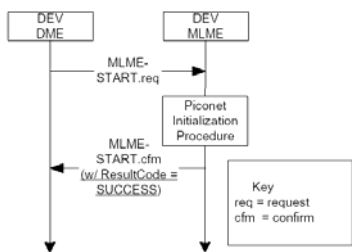

- MLME-START.request shall only to start its own piconet and shall not attempt to associate with an existing piconet.
- The DEV should choose the channel with the least amount of interference to start the piconet.

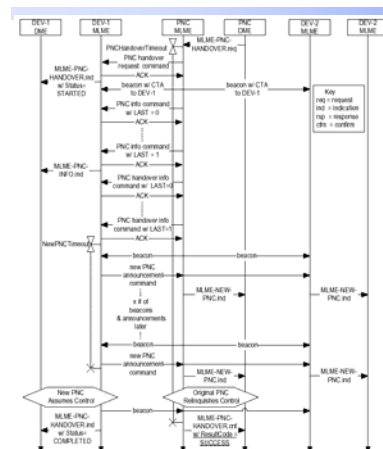

PNC Handover



- The AC bit in the capability field is used to indicate the a DEV is capable of being a PNC.
- The DEV shall always accept the nomination and obtain the DEV information from the current PNC within the indicated timeout period.



Comparison Order



Order	Information	Note
1	PNC Des-mode bit in capability field	PNC Des-mode=1 is preferred
2	SEC bit in capability field	SEC=1 is preferred
3	PSRC bit in capability field	PSRC=1 is preferred
4	PSAVE bit in capability field	PSAVE=1 is preferred
5	Max number GTS	Higher value is preferred
6	Transmitter power level (PHY dependent)	Higher value is preferred
7	MAX PHY rate (PHY dependent)	Higher value is preferred
8	DEV address	Higher value is preferred



Child Piconet

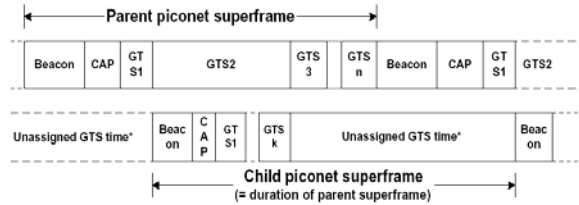

* The unassigned GTS slot time of the child piconet that is in the parent piconet's contention free period, may be used for establishing shared GTS slots for internetwork communication.



Process for Creating a Child Piconet

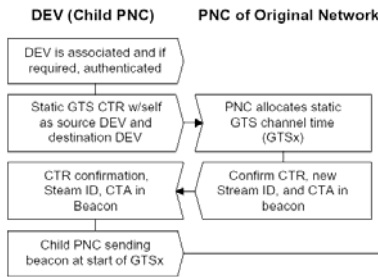

Neighbor Piconet

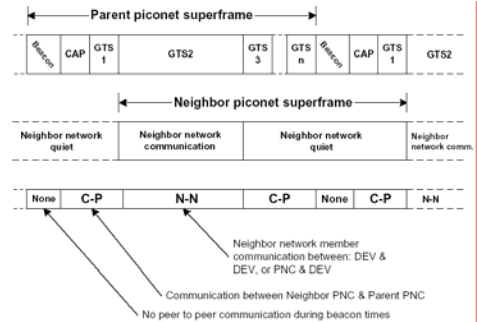

Process for Initiating of a Neighbor Piconet

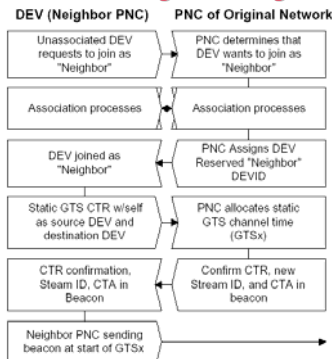

Channel Access

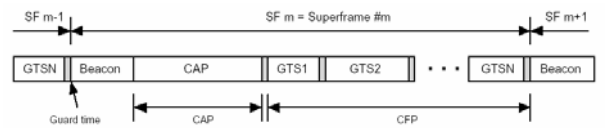

- CAP → CSMA/CA
- CFP → TDMA
- MTS → Slotted aloha



Guaranteed Time Slots (GTS)



- ◆ Dynamic GTS
 - The PNC moves a dynamic GTS by simply changing the CTA parameters in the beacon.
- ◆ Pseudo-Static GTS
 - Allocated only for stream connections.
 - PS-GTS may be moved within the CFP by the PNC, but the PNC needs to notify the affected DEVs by sending the probe command, with the new CTA.
- ◆ The algorithm used to allocate the channel time and assign GTSs is outside of the scope of this standard.



Management Time Slots (MTS)



- ◆ MTS is identical to GTS except that the PNC address is either the SrcID or the DestID in the CTA.
- ◆ Open MTS.
 - For command frame.
- ◆ Association MTS.
 - Support fast connections.



Synchronization

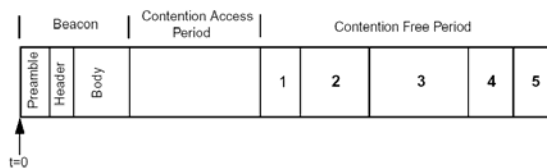

- Each DEV in the piconet, including the PNC, shall reset its clock to zero at the beginning of the beacon preamble.
- If a DEV does not hear a beacon, it should reset its clock to zero at the instant where it expects the beginning of the beacon preamble.



Scalable Security Capabilities



Capability	Mode 0 ⁽¹⁾	Mode 1	Mode 2
Cryptographic mutual authentication ⁽²⁾		X [ECMQV NTRUEncrypt RSA]	X [ECMQV RSA]
Data/Command integrity & auth. ⁽²⁾		X	X
Data privacy ⁽²⁾		X	X
Digital certificates ⁽³⁾			X

- PK Authentication: ECMQV 283-koblitz, NTRUEncrypt 251, RSA-OAEP 1024
- ⁽¹⁾ Mode 0 (no security) is mandatory. All other modes are optional
- ⁽²⁾ Shared key encryption and data authentication and integrity using AES-CCM
- ⁽³⁾ X.509 certificates for Mode2 (RSA & ECMQV) or implicit certificates (ECMQV) requiring interaction w/ an external trusted party

